

**Agilent U3401A
4 1/2 Digit Dual Display
Multimeter**

User's and Service Guide



Agilent Technologies

Notices

© Agilent Technologies, Inc. 2009

No part of this manual may be reproduced in any form or by any means (including electronic storage and retrieval or translation into a foreign language) without prior agreement and written consent from Agilent Technologies, Inc. as governed by United States and international copyright laws.

Manual Part Number

U3401-90001

Edition

First Edition, May 29, 2009

Printed in Malaysia

Agilent Technologies, Inc.
3501 Stevens Creek Blvd.
Santa Clara, CA 95051 USA

Warranty

The material contained in this document is provided “as is,” and is subject to being changed, without notice, in future editions. Further, to the maximum extent permitted by applicable law, Agilent disclaims all warranties, either express or implied, with regard to this manual and any information contained herein, including but not limited to the implied warranties of merchantability and fitness for a particular purpose. Agilent shall not be liable for errors or for incidental or consequential damages in connection with the furnishing, use, or performance of this document or of any information contained herein. Should Agilent and the user have a separate written agreement with warranty terms covering the material in this document that conflict with these terms, the warranty terms in the separate agreement shall control.

Technology Licenses

The hardware and/or software described in this document are furnished under a license and may be used or copied only in accordance with the terms of such license.

Restricted Rights Legend

U.S. Government Restricted Rights. Software and technical data rights granted to the federal government include only those rights customarily provided to end user customers. Agilent provides this customary commercial license in Software and technical data pursuant to FAR 12.211 (Technical Data) and 12.212 (Computer Software) and, for the Department of Defense, DFARS 252.227-7015 (Technical Data - Commercial Items) and DFARS 227.7202-3 (Rights in Commercial Computer Software or Computer Software Documentation).

Safety Notices

CAUTION

















A **CAUTION** notice denotes a hazard. It calls attention to an operating procedure, practice, or the like that, if not correctly performed or adhered to, could result in damage to the product or loss of important data. Do not proceed beyond a **CAUTION** notice until the indicated conditions are fully understood and met.

WARNING







A **WARNING** notice denotes a hazard. It calls attention to an operating procedure, practice, or the like that, if not correctly performed or adhered to, could result in personal injury or death. Do not proceed beyond a **WARNING** notice until the indicated conditions are fully understood and met.

Safety Symbols

The following symbol on the instrument and in the documentation indicates precautions that must be taken to maintain safe operation of the instrument.

| | | | |
|---|--|---|--|
|  | Direct current (DC) |  | Off (supply) |
|  | Alternating current (AC) |  | On (supply) |
|  | Both direct and alternating current |  | Caution, risk of electric shock |
|  | Three-phase alternating current |  | Caution, risk of danger (refer to this manual for specific Warning or Caution information) |
|  | Earth (ground) terminal |  | Caution, hot surface |
|  | Protective conductor terminal |  | Out position of a bi-stable push control |
|  | Frame or chassis terminal |  | In position of a bi-stable push control |
|  | Equipotentiality |  | Equipment protected throughout by double insulation or reinforced insulation |
| CAT II 300 V | IEC Measurement Category II. Measurement performed on circuits that are directly connected to the low voltage installation (up to 300 VAC) under Category II overvoltage conditions | | |

Regulatory Markings

| | | | |
|---|---|--|---|
|  | <p>The CE mark shows that the product complies with all the relevant European legal Directives (if accompanied by a year, it signifies when the design was proven).</p> |  | <p>The C-tick mark is a registered trademark of the Spectrum management Agency of Australia. This signifies compliance with the Australian EMC Framework regulations under the terms of the Radio Communications Act of 1992.</p> |
| <p>ICES/NMB-001</p> | <p>This ISM device complies with the Canadian ICES-001, Cet appareil ISM est conforme à la norme NMB-001 du Canada.</p> |  | <p>This product complies with the WEEE Directive (2002/96/EC) marking equipment. The affixed product label indicates that you must not discard this electrical/electronic product in domestic household waste.</p> |
|  | <p>The CSA mark is a registered trademark of the Canadian Standards Association.</p> |  |  |

General Safety Information

The following general safety precautions must be observed during all phases of operation, service, and repair of this instrument. Failure to comply with these precautions or with specific warnings elsewhere in this manual violates safety standards of design, manufacture, and intended use of the instrument. Agilent Technologies assumes no liability for the customer's failure to comply with these requirements.

WARNING

- **Do not defeat power cord safety ground feature. Plug in to a grounded (earthed) outlet.**
 - **Do not use product in any manner that is not specified by the manufacturer.**
 - **Double-check the multimeter's operation by measuring a known voltage.**
 - **For current measurement, turn off circuit power before connecting the multimeter to the circuit. Always place the multimeter in series with the circuit.**
 - **When connecting probes, always connect the common test probe first. When disconnecting probes, always disconnect the live test probe first.**
 - **Detach test probes from the multimeter before you open the battery cover.**
 - **Do not use the multimeter with the battery cover or part of the cover removed or loose.**
 - **Do not measure more than the rated voltage (as marked on the multimeter) between terminals, or between terminal and earth ground.**
 - **Do not use repaired fuses or short-circuited fuse-holders. For continued protection against fire, replace the line fuses only with fuses of the same voltage and current rating and recommended type.**
 - **Do not service or perform adjustments alone. Under certain conditions, hazardous voltages may exist, even with the multimeter switched off. To avoid dangerous electric shock, service personnel must not attempt internal service or adjustment unless another person, capable of rendering resuscitation or first aid, is present.**
 - **Do not substitute parts or modify multimeter to avoid the danger of introducing additional hazards. Return the product to Agilent Technologies Sales and Service Office for service and repair to ensure the safety features are maintained.**
 - **Do not operate damaged equipment as the safety protection features built into this product may have been impaired, either through physical damage, excessive moisture, or any other reason. Remove power and do not use the product until safe operation can be verified by service-trained personnel. If necessary, return the product to Agilent Technologies Sales and Service Office for service and repair to ensure the safety features are maintained.**
-

CAUTION

- Turn off circuit power and discharge all high-voltage capacitors in the circuit before you perform resistance, continuity, diodes, or capacitance tests.
 - Use the correct terminals, functions, and range for your instruments.
 - Never measure voltage when current measurement is selected.
 - Use the instrument with the cables provided.
 - Repair or service that is not covered in this manual should only be performed by qualified personnels.
-

Environmental Conditions

This instrument is designed for indoor use only. The table below shows the general environmental requirements for the product.

| Environmental Conditions | Requirements |
|--------------------------|--|
| Operating temperature | Full accuracy from 0 °C to 50°C (Operating) |
| Operating humidity | Full accuracy up to 80 % R.H. (relative humidity) for temperature up to 28°C |
| Storage temperature | –20 °C to 60 °C (Non-operating) |
| Altitude | Operating up to 2,000 metres (6,562feet) |
| Pollution degree | Pollution Degree 2 |

CAUTION

The Agilent U3401A dual display complies with the following EMC requirements:

- IEC 61010-1:2001/EN61010-1:2001 (2nd Edition)
- Canada: CAN/CSA-C22.2 No. 61010-1-04
- USA: ANSI/UL 61010-1:2004
- IEC 61326-1:2005/EN61326-1:2006
- Canada: ICES/NMB-001:2004
- Australia/New Zealand: AS/NZS CISPR11:2004

Waste Electrical and Electronic Equipment (WEEE) Directive 2002/96/EC

This instruction complies with the WEEE Directive (2002/96/EC) marking requirement. This affixed product label indicates that you must not discard this electrical/electronic product in domestic household waste.

Product Category:

With reference to the equipment types in the WEEE directive Annex 1, this instrument is classified as a "Monitoring and Control Instrument" product.

The affixed product label is shown as below:



Do not dispose in domestic household waste

To return this unwanted instrument, contact your nearest Agilent office, or visit

www.agilent.com/environment/product

for more information.

| | | |
|---|--|---|
|  Agilent Technologies | DECLARATION OF CONFORMITY According to EN ISO/IEC 17050-1:2004 |  |
|---|--|---|

Manufacturer's Name: Agilent Technologies Microwave Products (M) Sdn Bhd
Manufacturer's Address: Bayan Lepas Free Industrial Zone
 11900 Penang, Malaysia

Declares under sole responsibility that the product as originally delivered:

Product Name: 5½ Digit Dual Display Multimeter (U3402A)
 4½ Digit Dual Display Multimeter (U3401A)
Model Number: U3401A, U3402A
Product Option: This declaration covers all options of the above product(s)

complies with the essential requirements of the following applicable European Directives, and carries the CE marking accordingly:

Low Voltage Directive (2006/95/EC)
 EMC Directive (2004/108/EC)

and conforms with the following standards:

| EMC Standards | Limit |
|--|--|
| IEC61326-1:2005 / EN61326-1:2006 | |
| ▪ CISPR 11:2003 / EN 55011:2007 | Group 1 Class A |
| ▪ IEC 61000-4-2:2001 / EN 61000-4-2:1995+A1:1998+A2:2001 | 4 kV CD, 8 kV AD |
| ▪ IEC 61000-4-3:2002 / EN 61000-4-3:2002 | 10 V/m (80 MHz-1.0 GHz) 3 V/m (1.4 GHz-2.0 GHz) 1 V/m (2.0 GHz-2.7 GHz) |
| ▪ IEC 61000-4-4:2004 / EN 61000-4-4:2004 | 1 kV signal lines, 2 kV power lines |
| ▪ IEC 61000-4-5:2001 / EN 61000-4-5:1995+A1:2001 | 1 kV line-line, 2 kV line-ground |
| ▪ IEC 61000-4-6:2003 / EN 61000-4-6:2007 | 3 V (0.15 MHz-80 MHz) |
| ▪ IEC 61000-4-11:2004 / EN 61000-4-11:2004 | 100% Dip (0.5 cycle, 1 cycle) 60% Dip (10 cycles) 30% Dip (25 cycles) 100% short interruptions (250 cycles) |

Canada: ICES/NMB-001:2004
 Australia/New Zealand: AS/NZS CISPR 11:2004

Safety IEC 61010-1:2001 / EN 61010-1:2001
 CAN/CSA-C22.2 No.61010-1-04
 ANSI/UL61010-1:2004

Additional Information:

The product was tested in a typical configuration with Agilent Technologies test systems.

This DoC applies to above-listed products placed on the EU market after:

| | |
|---|---|
| 5-Mar-09 <hr style="width: 100%;"/> Date |  <hr style="width: 100%;"/> Tay Eng Su Quality Manager |
|---|---|

For further information, please contact your local Agilent Technologies sales office, agent or distributor, or Agilent Technologies Deutschland GmbH, Herrenberger Straße 130, 71034 Böblingen, Germany.

Product Regulations

| EMC | Standards | Performance Criteria |
|-----|--|----------------------|
| | IEC61326-1:2005 / EN61326-1:2006 | |
| | ▪ CISPR 11:2003 / EN 55011:2007 | Group 1 Class A |
| | ▪ IEC 61000-4-2:2001 / EN 61000-4-2:1995+A1:1998+A2:2001 | A |
| | ▪ IEC 61000-4-3:2002 / EN 61000-4-3:2002 | A |
| | ▪ IEC 61000-4-4:2004 / EN 61000-4-4:2004 | A |
| | ▪ IEC 61000-4-5:2001 / EN 61000-4-5:1995:A1:2001 | A |
| | ▪ IEC 61000-4-6:2003 / EN 61000-4-6:2007 | A |
| | ▪ IEC 61000-4-11:2004 / EN 61000-4-11:2004 | |
| | ○ 100% Dip (0.5 cycle) | A |
| | ○ 100% Dip (1 cycle) | A |
| | ○ 60% Dip (10 cycles) | B |
| | ○ 30% Dip (25 cycles) | A |
| | ○ 100% Short Interruptions (250 cycles) | B |

¹Performance Criteria:

A Pass - Normal operation, no effect.

B Pass - Temporary degradation, self recoverable.

C Pass - Temporary degradation, operator intervention required.

D Fail - Not recoverable, component damage.

N/A – Not applicable

Notes:

Regulatory Information for Canada

ICES/NMB-001:2004

This ISM device complies with Canadian ICES-001.

Cet appareil ISM est conforme à la norme NMB-001 du Canada.

Regulatory Information for Australia/New Zealand

This ISM device complies with Australian/New Zealand AS/NZS CISPR11:2004

 **N10149**

In This Guide ...

- 1 Getting Started** Chapter 1 prepares the U3401A digital multimeter for use and contains a brief description of the digital multimeter front panel, display, keypad, terminal and rear panel.
- 2 Operations and Features** Chapter 2 contains detailed information on how to take measurements using the U3401A. It also describes the various multimeter function and features available in the multimeter.
- 3 Measurement Tutorial** Chapter 3 describes the advanced features and applications for effective operation of the multimeter.
- 4 Performance Test** Chapter 4 contains performance test procedures and calibration procedures. The performance tests procedures allow you to verify that the multimeter is operating within its published specifications.
- 5 Disassembly and Repair** Chapter 5 describes how to disassemble the multimeter, how to obtain repair services, and lists replaceable parts.
- 6 Specifications and Characteristics** Chapter 6 specifies the characteristics, and specifications of the U3401A.

Contents

| | |
|----------------------------|------|
| Notices | ii |
| Safety Symbols | iii |
| Regulatory Markings | iv |
| General Safety Information | v |
| Environmental Conditions | viii |
| In This Guide ... | xii |

1 Getting Started

| | |
|---|----|
| Introduction the Agilent U3401A Dual Display Multimeter | 2 |
| Initial Inspection | 3 |
| Connecting Power to the Instrument | 5 |
| Adjusting the Handle | 7 |
| Product at a Glance | 8 |
| Product Dimensions | 8 |
| The Front Panel at a Glance | 9 |
| The Display at a Glance | 10 |
| The Keypad at a Glance | 12 |
| The Terminal at a Glance | 15 |
| The Rear Panel at a Glance | 17 |

2 Operations and Features

| | |
|---|----|
| Making Measurements | 20 |
| Performing Voltage Measurements | 21 |
| Performing Current Measurements | 23 |
| Performing Frequency Measurements | 25 |
| Performing Resistance/Continuity Measurements | 26 |
| Performing Diode and Continuity Test | 27 |
| Selecting a Range | 30 |
| Selecting Secondary Display | 32 |
| Using the Setup Menu | 34 |
| Changing the Configurable Settings | 35 |
| Selecting Local Operation Mode | 36 |

| | |
|--------------------------|----|
| Operating Math Functions | 37 |
| dBm | 38 |
| Rel | 39 |
| MinMax | 40 |
| Comp | 42 |
| Hold | 44 |
| Percentage (%) | 46 |
| Trigger Mode | 47 |

3 Measurement Tutorial

| | |
|---|----|
| Applications for Using Dual Display | 50 |
| Dual Display Operation Examples | 51 |
| Measure DC Voltage and AC Ripple on a Rectification Circuit | 51 |
| Measure AC and DC Current on a Rectification Circuit | 52 |
| Measuring AC Voltage and Frequency on an AC Circuit | 53 |
| Measuring Resistance | 54 |
| Measure True RMS AC + DC | 55 |

4 Performance Test

| | |
|---|----|
| Calibration Overview | 58 |
| Recommended Test Equipment | 59 |
| Agilent Technologies Calibration Services | 58 |
| Calibration Interval | 58 |
| Test Considerations | 60 |
| Input Connections | 60 |
| Performance Verification Tests Overview | 61 |
| Performance Verification Tests | 61 |
| DC Voltage Verification Test | 61 |
| DC Current Verification Test | 62 |
| Resistance Verification Test | 64 |
| Diode Verification Test | 65 |
| Frequency Verification Test | 65 |
| AC Voltage Verification Test | 66 |
| AC Current Verification Test | 67 |

5 Disassembly and Repair

- Operating Checklist 70
 - Types of Service Available 71
 - Repackaging for Shipment 72
 - Cleaning 72
- To Replace the Power Line Fuse 73
- To Replace a Current Input Fuse 74
- Electrostatic Discharge (ESD) Precautions 74
- Mechanical Disassembly 75
- Replaceable Parts 81
- Rack Mounting 82

6 Specifications and Characteristics

- General Characteristics 84
- Measurement Category 86
 - Measurement Category Definitions 86
- Specifications 87
 - DC Voltage 87
 - DC Current 87
 - AC Voltage (true RMS, AC Coupling mode) 88
 - AC Voltage (true RMS, AC+DC Coupling mode) 88
 - AC Current (true RMS, AC Coupling mode) 89
 - AC Current (true RMS, AC+DC Coupling mode) 90
 - Resistance / Continuity 90
 - Diode Test/ Continuity 91
 - Frequency 91
 - Decibel Calculation 92
- Supplemental Specifications 93
 - Display Counts and Reading Rates 93
 - Measurement Specifications 93
- To Calculate Total Measurement Error 98
- Accuracy Specifications 99
 - Transfer Accuracy 99
 - One-Year Accuracy 99
 - Temperature Coefficients 99

List of Figures

- Figure 1-1 Stacking the U3401A 6
- Figure 1-2 Type of handle position 7
- Figure 1-3 Attaching and detaching the handle 7
- Figure 1-4 U3401A dimensions 8
- Figure 1-5 Front panel 9
- Figure 1-6 VFD full display with all segments illuminated 10
- Figure 1-7 Keypad 12
- Figure 1-8 Input terminals 15
- Figure 1-9 Rear panel 17
- Figure 2-1 ACV terminal connection and display 21
- Figure 2-2 DCV terminal connection and display 22
- Figure 2-3 ACI RMS or DCI (mA) terminal connection and display 23
- Figure 2-4 ACI RMS or DCI (10A) terminal connection and display 24
- Figure 2-5 Frequency terminal connection and display 25
- Figure 2-6 Resistance /continuity terminal connection and display 26
- Figure 2-7 Forward-biased diode/continuity test terminal connection and display 28
- Figure 2-8 Reverse-biased diode/continuity terminal connection and display 29
- Figure 2-9 Secondary display 32
- Figure 2-10 Typical dBm operation display 38
- Figure 2-11 Typical Rel operation display 39
- Figure 2-12 Typical Max operation display 40
- Figure 2-13 Typical Min operation display 40
- Figure 2-14 Typical Comp operation display 42
- Figure 2-15 Typical Hold operation display 44
- Figure 2-16 Typical refresh hold operation display 45
- Figure 2-17 Typical percentage (%) operation display 46
- Figure 2-18 Typical Trigger mode display 48
- Figure 3-1 Connection terminal when measuring DC voltage and AC ripple 51
- Figure 3-2 Connection terminal when using DC current and AC ripple 52
- Figure 3-3 Connection terminal when measuring AC Voltage and Frequency 53
- Figure 3-4 Connection terminal when measuring Resistance 54

List of Tables

| | | |
|------------|---|----|
| Table 1-1 | Display annunciators | 10 |
| Table 1-2 | Keypad functions | 12 |
| Table 1-3 | Input terminal for different functions | 16 |
| Table 2-1 | Range scale value | 31 |
| Table 2-2 | Description for dual display combination | 33 |
| Table 2-3 | Setup menu and communications parameters | 34 |
| Table 2-4 | Math operations for different measurement functions | 37 |
| Table 3-1 | Typical combinations and applications when using dual display | 50 |
| Table 4-1 | Recommended test equipments | 59 |
| Table 4-2 | DC voltage verification test | 62 |
| Table 4-3 | DC current verification test | 63 |
| Table 4-4 | 2-wire Ω verification test | 64 |
| Table 4-5 | Diode verification test | 65 |
| Table 4-6 | Frequency verification test | 65 |
| Table 4-7 | AC volts verification test | 66 |
| Table 4-8 | AC current verification test | 67 |
| Table 5-1 | Type of supplied fuse (according to country of destination) | 73 |
| Table 5-2 | Replaceable Parts | 81 |
| Table 6-1 | DCV resolution, full scale reading and accuracy [\pm (% of reading + count)] | 87 |
| Table 6-2 | DCI resolution, full scale reading and accuracy [\pm (% of reading + count)] | 87 |
| Table 6-3 | ACV resolution and full scale reading [\pm (% of reading + count)] | 88 |
| Table 6-4 | ACVac+dc resolution and full scale reading [\pm (% of reading + count)] | 88 |
| Table 6-5 | ACI resolution, full scale reading, and burden voltage [\pm (% of reading + count)] | 89 |
| Table 6-6 | ACIac+dc resolution, full scale reading, and burden voltage [\pm (% of reading + count)] | 90 |
| Table 6-7 | Resistance resolution, full scale reading, and accuracy [\pm (% of reading + count)] | 90 |
| Table 6-8 | Diode / continuity resolution and full scale reading | 91 |
| Table 6-9 | Frequency resolution and accuracy [\pm (% of reading + count)] | 91 |
| Table 6-10 | Sensitivity for voltage measurement | 91 |
| Table 6-11 | Sensitivity for current measurement | 92 |
| Table 6-12 | Range and accuracy (dB) | 92 |
| Table 6-13 | Full scale display counts | 93 |
| Table 6-14 | Supplemental measurement specifications | 93 |

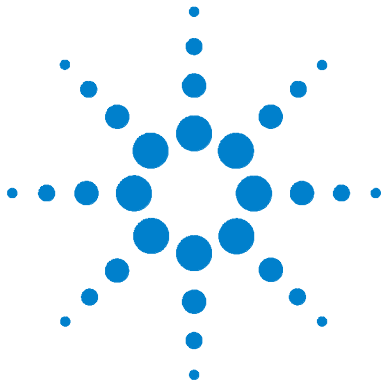

1 Getting Started

| | |
|---|----|
| Introduction the Agilent U3401A Dual Display Multimeter | 2 |
| Initial Inspection | 3 |
| Connecting Power to the Instrument | 5 |
| Stacking the U3401A | 6 |
| Adjusting the Handle | 7 |
| Product at a Glance | 8 |
| Product Dimensions | 8 |
| The Front Panel at a Glance | 9 |
| The Display at a Glance | 10 |
| The Keypad at a Glance | 12 |
| The Terminal at a Glance | 15 |
| The Rear Panel at a Glance | 17 |

This chapter prepares the U3401A digital multimeter for use and contains brief description of the digital multimeter front panel, display, keypad, terminal and rear panel.



Introduction the Agilent U3401A Dual Display Multimeter

The key features of the U3401A dual display multimeter are:

- 4 1/2-digit dual display measurement
- Ten Measurement functions:
 - AC voltage
 - DC voltage
 - AC current
 - DC current
 - AC + DC voltage
 - AC + DC current
 - Resistance
 - Frequency
 - Continuity test
 - Diode test
- Six Math operations:
 - dBm
 - MINMAX
 - Hold
 - Relative (REL)
 - Compare (COMP)
 - Percentage (%)
- 50,000 count dual display.
- AC and DC current measurements to 10 A.
- Resistance measurement up to 50 M Ω , 10 m Ω resolution.
- Frequency measurement up to 500 kHz with 0.01 Hz resolution.
- Measurement of dBm with variable reference impedance from 2 Ω to 8000 Ω .

Initial Inspection

- 1 Inspect the shipping container for damage. Signs of damage may include a dented or torn shipping container or cushioning material that shows signs of unusual stress or compacting.
- 2 Carefully remove the contents from the shipping container and verify that your order is complete.

NOTE

- If the shipping container or packaging material is damaged, it should be kept until the contents have been checked mechanically and electrically. If there is mechanical damage, notify the nearest Agilent Technologies office. Keep the damaged shipping materials (if any) for inspection by the carrier and Agilent representative. If required, you can find a list of Agilent Sales and Service Offices on the last page of this guide.
- Ensure you have read and understand the preceding safety information before you proceed.

Standard purchase items

Verify that you have received the following items with your multimeter:

- ✓ Power cord
- ✓ Standard test lead kit
- ✓ Printed quick start guide
- ✓ Product reference CD
- ✓ Test report
- ✓ Certificate of calibration

Verify that any options ordered are included with the shipment by checking the packing list included with the shipment.

Original packaging

Containers and materials identical to those used in the factory packaging are available through Agilent Technologies office. If the instrument is being returned to Agilent Technologies for servicing, attach a tag indicating the type of service required, return address, model number, and serial number. Also mark the container FRAGILE to assure careful handling. In any correspondence, refer to the instrument by model number and serial number.

Connecting Power to the Instrument

Connect the power cord and press the power switch to turn on the multimeter.

The front panel display illuminates while the multimeter performs its power-on self-test. (If the multimeter does not power-on, refer “[Operating Checklist](#)” on page 70).

During the power-on session, press  to hold the full display. Press any key to resume the power-on self-test.

The multimeter powers up in the DC voltage function with autoranging enabled. If self-test is successful, the multimeter goes to normal operation. If the self-test fails, either a full annunciator or a blank display is displayed without entering the normal operation. If the unlikely event that self-test repeatedly fails, contact your nearest Agilent Sales and Service Office

NOTE

The multimeter will operate at any line voltage between 90 VAC and 264 VAC when the line voltage selector is set properly with frequency range 50 Hz or 60 Hz.

CAUTION

- Before turning on the multimeter, make sure the line voltage selector is set to the correct position for the applied line voltage to the power line cord connector.
- Do not apply a line voltage that exceeds the specified range of the line cord connector.

Stacking the U3401A

The U3401A is provided with specially designed anti-slip protective bumpers on the front and rear panel. The multimeters will not slide off when stacked on top of each other.

To be able to stack the U3401A multimeters, ensure the attached bumpers are in correct orientation. See [Figure 1-1](#).

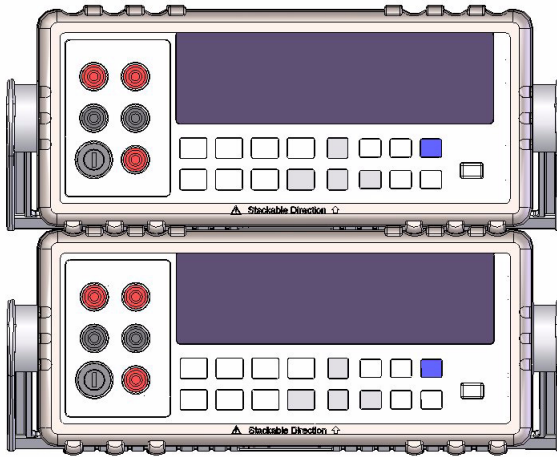

Figure 1-1 Stacking the U3401A

Adjusting the Handle

To adjust the handle, grasp the handle by the side and pull outward. Then, rotate the handle to the desired position. Below are the possible handle positions.

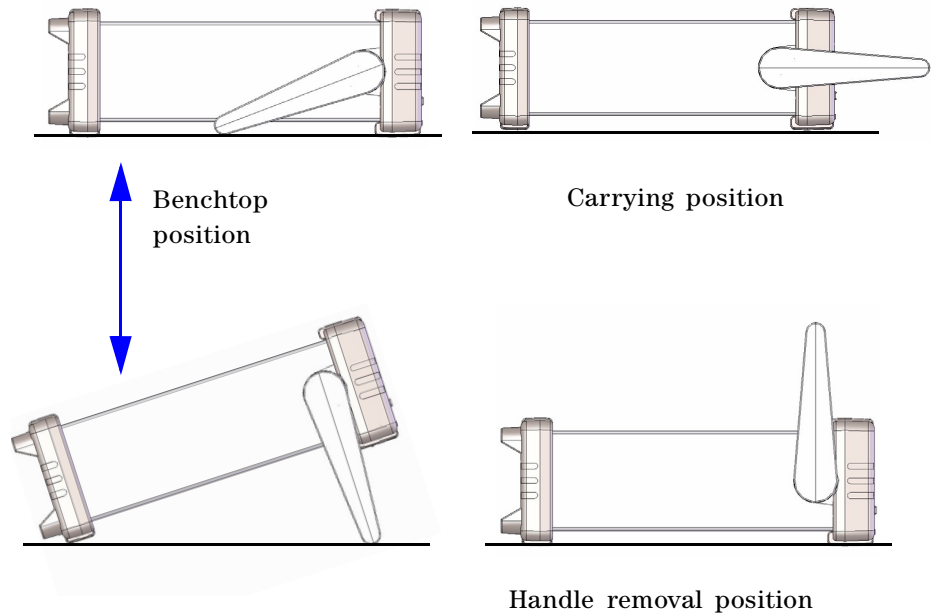

Figure 1-2 Type of handle position

To attach or detach the handle, rotate the handle upright and pull it out from the sides of the instrument. See [Figure 1-3](#)

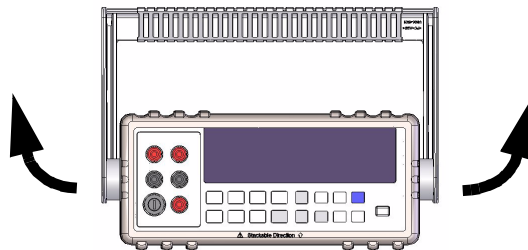
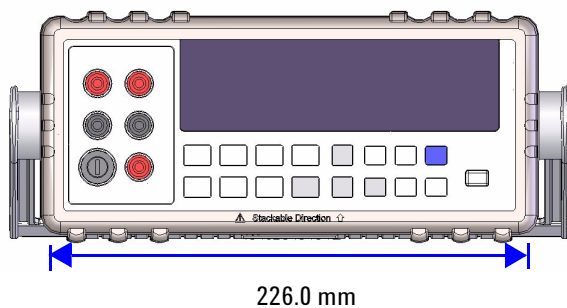

Figure 1-3 Attaching and detaching the handle

Product at a Glance

Product Dimensions

Front View



Side View

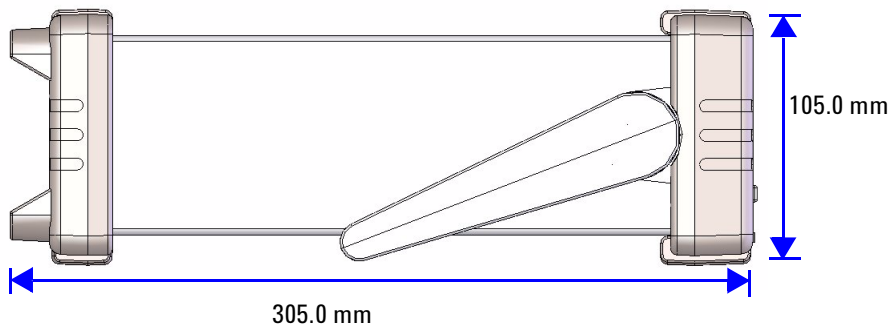

Figure 1-4 U3401A dimensions

The Front Panel at a Glance

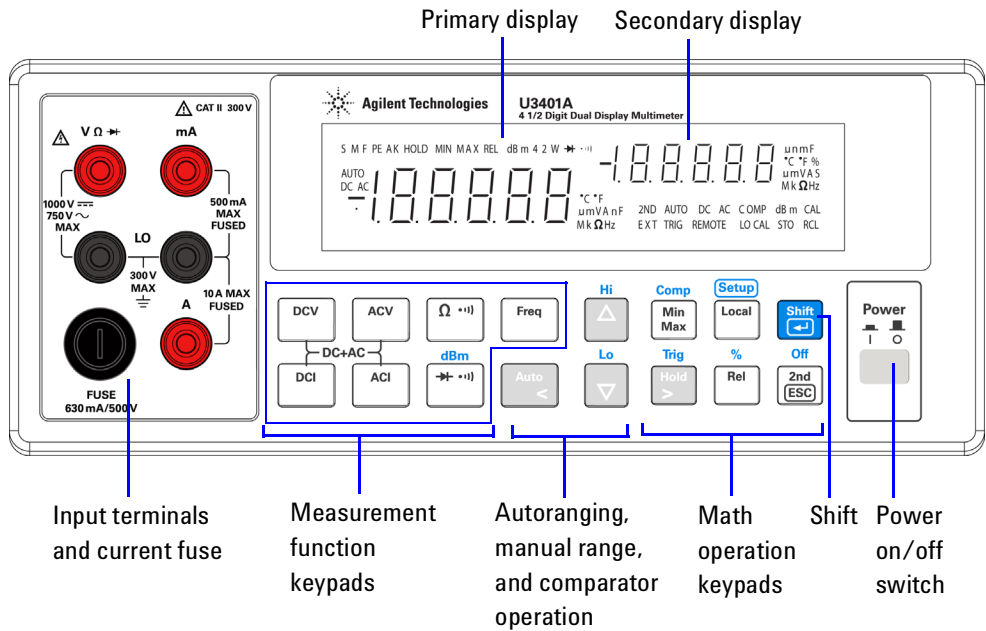

Figure 1-5 Front panel

The Display at a Glance

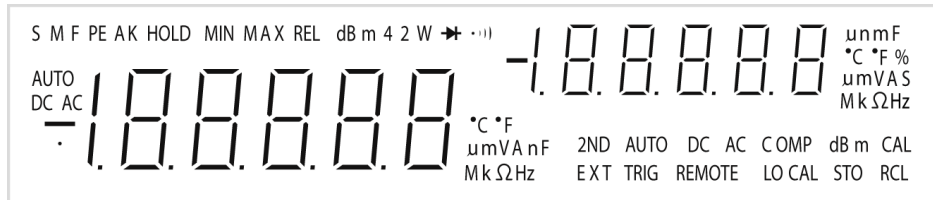



Figure 1-6 VFD full display with all segments illuminated

The highly visible vacuum fluorescent display (VFD) annunciators are described in [Table 1-1](#).

Table 1-1 Display annunciators

| Annunciator | Description |
|------------------------|---|
| Primary display | |
| S | Reading rate: Slow. Not applicable for the U3401A. |
| M | Reading rate: Medium. Not applicable for the U3401A. |
| F | Reading rate: Fast. Not applicable for the U3401A. |
| PEAK | Peak measurement. Not applicable for the U3401A. |
| HOLD | Data hold |
| MIN | MinMax math operation: Minimum value shown on the primary display |
| MAX | MinMax math operation: Maximum value shown on the primary display |
| REL | Relative value |
| dBm | Decibel unit relative to 1 mW |
| 4 2 W | 4-wire/2-wire resistance. Not applicable for the U3401A. |
| → | Diode test |
| ·)) | Audible continuity test for resistance |
| AUTO | Autoranging |
| DC | Direct current |
| AC | Alternating current |
| DCAC | AC + DC |

| Annunciator | Description |
|---|--|
|  | Polarity, digits, and decimal points for primary display |
| °C | Celcius temperature unit. Not applicable for the U3401A. |
| °F | Fahrenheit temperature unit. Not applicable for the U3401A. |
| mV | Voltage unit: mV, V |
| µmA | Current unit: µA, mA, A |
| µmF | Capacitance unit: µF, nF, mF |
| MkΩ | Resistance unit: Ω, kΩ, MΩ |
| MkHz | Frequency unit: Hz, kHz, MHz |
| Secondary display | |
|  | Polarity, digits, and decimal points for primary display |
| µmF | Capacitance unit: µF, nF, mF |
| °C | Celcius temperature unit. Not applicable for the U3401A. |
| °F | Fahrenheit temperature unit. Not applicable for the U3401A. |
| % | Duty cycle measurement |
| mV | Voltage unit: mV, V |
| µmA | Current unit: µA, mA, A |
| S | Shift mode |
| MkΩ | Resistance unit: Ω, kΩ, MΩ |
| 2ND | Secondary display is enabled. Not applicable for the U3401A. |
| AUTO | Autoranging |
| DC | Direct current |
| AC | Alternating current |
| DCAC | AC + DC |
| COMP | Compare operation |
| dBm | Decibel unit relative to 1 mW |
| CAL | Calibration mode |
| EXT | External. Not applicable for the U3401A. |
| TRIG | Trigger mode |
| REMOTE | Remote interface control. For calibration use only. |
| LOCAL | Local mode |
| STO | Store instrument state. Not applicable for the U3401A. |
| RCL | Recall stored instrument state. Not applicable for the U3401A. |

The Keypad at a Glance

The operation for each key is shown on [Table 1-2](#). Pressing a key changes the current key operation, illuminates the related symbol on the display and emits a beep.



Figure 1-7 Keypad

Table 1-2 Keypad functions





| Key | Description |
|---|---|
| System related operation | |
|  | Press to power-on or power-off the U3401A multimeter. |
|  | Press to select Shift. |
|  | Press to return the multimeter to front panel operation when it is in remote state. |
|  | Press to step through the Setup menu. See “Using the Setup Menu” on page 34 for more information. |
|  | Press to enable the secondary display. |

Table 1-2 Keypad functions

















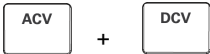
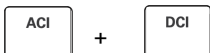



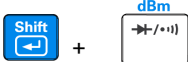





| Key | Description |
|---|--|
| Measurement related operation | |
|  +  | Press to disable the secondary display. |
|  | Press to select the DC voltage measurement. |
|  | Press to select the AC voltage measurement. |
|  | Press to select the DC current measurement. |
|  | Press to select the AC current measurement. |
|  | Press to select the AC + DC voltage measurement. |
|  | Press to select AC + DC current measurement. |
|  | Press to select the frequency measurement. |
|  | Press to toggle between the diode and continuity measurement. |
|  | Press to toggle between resistance or resistance continuity. |
|  | Press to select dBm measurement. |
|  | Press to toggle between manual ranging and autoranging. |
|  | Press to select a higher range and disable autoranging. See “Selecting a Range” on page 30 for more information. |

Table 1-2 Keypad functions

| Key | Description |
|--|---|
| Measurement related operation | |
| <div style="text-align: center;"> Lo  </div> | Press to select a lower range and disable autoranging. See “Selecting a Range” on page 30 for more information. |
| <div style="display: flex; align-items: center; justify-content: center;"> <div style="text-align: center; margin-right: 10px;"> Shift  </div> <div style="text-align: center; margin-right: 10px;">+</div> <div style="text-align: center;"> Comp  </div> </div> | Press to select Compare math operation. |
| <div style="display: flex; align-items: center; justify-content: center;"> <div style="text-align: center; margin-right: 10px;"> Shift  </div> <div style="text-align: center; margin-right: 10px;">+</div> <div style="text-align: center;"> Hi  </div> </div> | Press to select and set the high limit for Compare math operation. |
| <div style="display: flex; align-items: center; justify-content: center;"> <div style="text-align: center; margin-right: 10px;"> Shift  </div> <div style="text-align: center; margin-right: 10px;">+</div> <div style="text-align: center;"> Lo  </div> </div> | Press to select and set the low limit for Compare math operation. |
| <div style="text-align: center;"> Trig  </div> | Press to enable Hold math operation. See “Hold” on page 43 for more information. |
| <div style="display: flex; align-items: center; justify-content: center;"> <div style="text-align: center; margin-right: 10px;"> Shift  </div> <div style="text-align: center; margin-right: 10px;">+</div> <div style="text-align: center;"> dBm  </div> </div> | Press to select the reference impedance for dBm measurement. |
| <div style="text-align: center;"> Comp  </div> | Press to enable the MinMax math operation. |
| <div style="text-align: center;"> %  </div> | Press to select the Relative math operation. |
| <div style="display: flex; align-items: center; justify-content: center;"> <div style="text-align: center; margin-right: 10px;"> Shift  </div> <div style="text-align: center; margin-right: 10px;">+</div> <div style="text-align: center;"> %  </div> </div> | Press to select the Percentage operation. |

The Terminal at a Glance

CAUTION

To avoid damaging this multimeter, do not exceed the rated input limit.

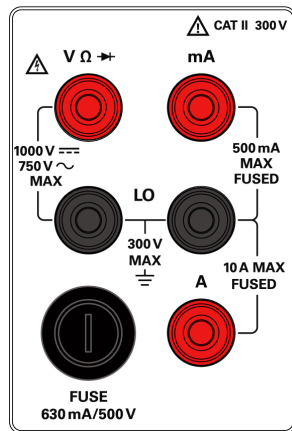

Figure 1-8 Input terminals

NOTE

Voltages above 300 VAC may be measured only in circuits that are isolated from mains. However, transient overvoltages are also present on circuits that are isolated from mains. The Agilent U3401A is designed to safely withstand occasional transient overvoltages up to 2500 V PEAK. Do not use this multimeter to measure circuits where transient overvoltages could exceed this level.

Table 1-3 Input terminal for different functions

| Measurement function | Input terminal | Overload protection |
|----------------------------------|--------------------------|---|
| DC voltage (VDC) | V Ω \rightarrow | 1000 VDC |
| AC voltage (VAC), frequency (Hz) | V Ω \rightarrow | 750 VAC RMS, 1100 V PEAK, 2×10^7 V-Hz normal mode, or 1×10^6 V-Hz common mode |
| Miliampere (mA), frequency (Hz) | mA | 500 mADC or AC RMS |
| 10 A, frequency (Hz) | 10 A | 10 ADC or AC RMS continuous, and >10 A DC RMS for 20 seconds maximum |
| Resistance (Ω) | V Ω \rightarrow | 500 VDC or AC RMS |
| Diode test, continuity test | V Ω \rightarrow | 500 VDC or AC RMS |
| All functions | Any terminal to earth | 1000 VDC or AC PEAK |

The Rear Panel at a Glance

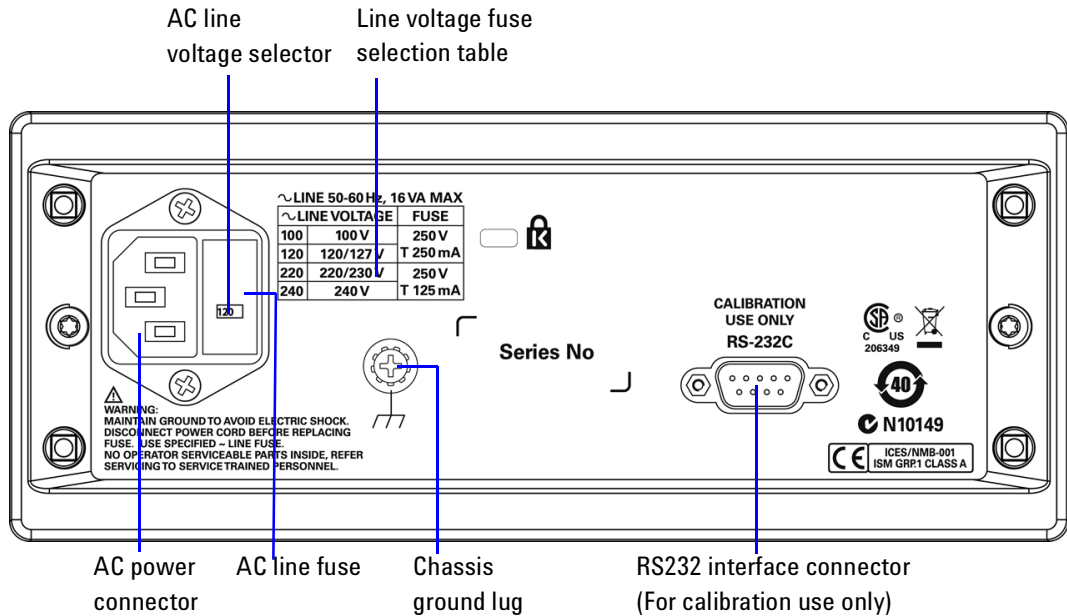

Figure 1-9 Rear panel

1 Getting Started



2 Operations and Features

| | |
|---|----|
| Making Measurements | 20 |
| Performing Voltage Measurements | 21 |
| Performing Current Measurements | 23 |
| Performing Frequency Measurements | 25 |
| Performing Resistance/Continuity Measurements | 26 |
| Performing Diode and Continuity Test | 27 |
| Selecting a Range | 30 |
| Selecting Secondary Display | 32 |
| Using the Setup Menu | 34 |
| Changing the Configurable Settings | 35 |
| Selecting Local Operation Mode | 36 |
| Operating Math Functions | 37 |
| dBm | 38 |
| Rel | 39 |
| MinMax | 40 |
| Comp | 42 |
| Hold | 44 |
| Percentage (%) | 46 |
| Trigger Mode | 47 |

This chapter contains detailed information on how to take measurements using the U3401A. It also describes the various multimeter function and features available in the multimeter.



Making Measurements

The following pages show you how to make measurement connections and how to select measurement functions from the front panel for each of the measurement functions.

NOTE

- After measuring a high voltage measurement of up to 1000 VDC, you are recommended to wait for approximate two minutes before measuring a low-level measurement with 1 to 10 μV resolutions
 - After measuring a high current measurement using the A input terminal, you are recommended to wait for approximate ten minutes before measuring a low-level DC measurements of volts, amperes, or ohms; to achieve accurate measurement. This is due to the thermal voltages generated during the high current measurements that may cause errors when measuring the low-level measurements.
-

Performing Voltage Measurements

CAUTION

Ensure that the terminal connections are connected correctly before making any measurement. To avoid damaging the multimeter, do not exceed the rated input limit.

Measuring AC Voltage

- Five ranges: 500.00 mV, 5.00 V, 50.00 V, 500.00 V, 750.00 V
- Measurement method: AC coupled true RMS—measure the AC component with up to 400 VDC bias on any range
- Crest factor: Maximum 3:0 at full scale
- Input impedance: $1\text{ M}\Omega \pm 2\%$ parallel with capacitance $<100\text{ pF}$ on all ranges
- Input protection: 750 V RMS on all ranges

- 1 Press .
- 2 Connect the red and black test leads to the respective input terminals as shown in [Figure 2-1](#).
- 3 Probe the test points and read the display.

In autoranging mode, the multimeter automatically selected the appropriate range and the measurement is displayed.



Figure 2-1 ACV terminal connection and display

2 Operations and Features

Measuring DC Voltage

- Five ranges: 500.00 mV, 5.00 V, 50.00 V, 500.00 V, 1000.00 V
- Measurement method: Sigma Delta A-to-D converter
- Input impedance: 10 M Ω ±2% range (typical)
- Input protection: 1000 V on all ranges

- 1 Press .
- 2 Connect the red and black test leads to the respective input terminals as shown in [Figure 2-2](#).
- 3 Probe the test points and read the display.

In autoranging mode, the multimeter automatically selects the appropriate range and the measurement is displayed.

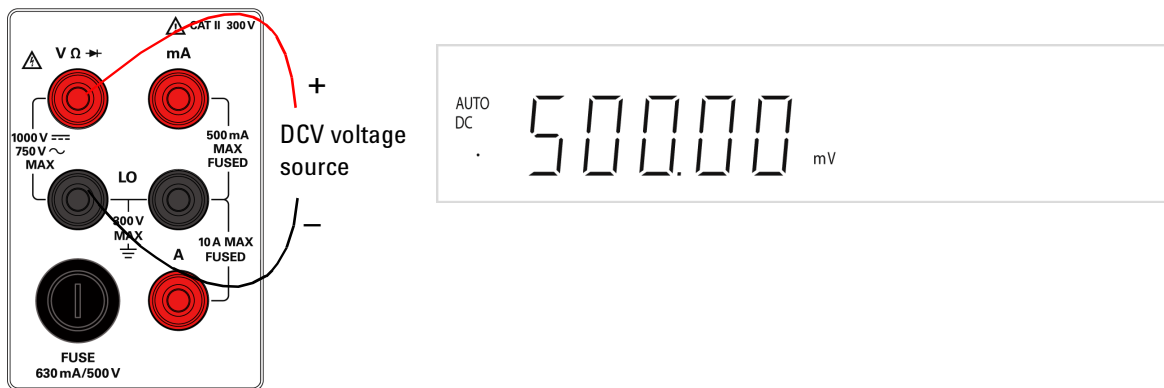

Figure 2-2 DCV terminal connection and display

Performing Current Measurements

Measuring AC (RMS) or DC Current in mA

- Six ranges: 500.00 mA, 5.00 mA, 50.00 mA, 500.00 mA, 5.00 A, 10.00 A
- Shunt resistance: 0.01 Ω to 100 Ω for 500 μ A to 10 A ranges
- Input protection: Internal 25A, 440 V FH fuse for one terminal

- 1 Press or .
- 2 Power off the measured circuit.
- 3 Connect the red and black test leads to mA input terminal as shown in [Figure 2-3](#).
- 4 Probe the test points in series with the circuit.
- 5 Power on the measured circuit and read the display.

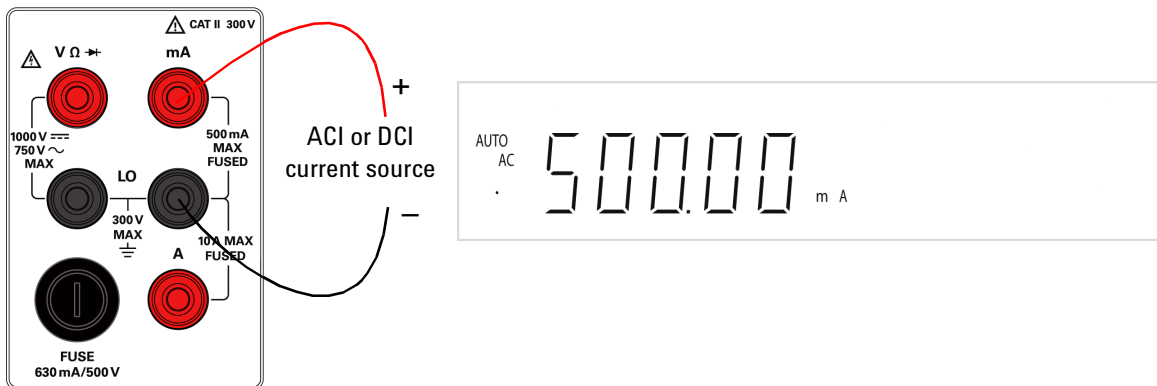

Figure 2-3 ACI RMS or DCI (mA) terminal connection and display

2 Operations and Features

Measuring AC(RMS) or DC Current up to 10 A

- One range: 10.000 A for DC or AC RMS continuous
12.000 A DC or AC RMS for maximum 30 seconds
- Shunt resistance: 0.01 Ω to 100 Ω for 500 μ A to 10 A ranges
- Input protection: Internal 25 A, 440 V fuse for 10A terminal

- 1 Press or .
- 2 Power off the measured circuit.
- 3 Connect the red and black test leads to the A input terminal as shown in [Figure 2-4](#).
- 4 Probe the test points in series with the circuit.
- 5 Power on the measured circuit and read the display.



Figure 2-4 ACI RMS or DCI (10A) terminal connection and display

Performing Frequency Measurements

WARNING

Use the frequency counter for low voltage applications. Do not use the frequency counter on AC power line systems.

Measuring frequency

- Four ranges: 500.00 Hz, 5.0000 Hz, 50.000 Hz, 500.000 Hz, 750.00 V — range is based on the voltage level of the signal, not frequency.
- Measurement method: Reciprocal counting technique. AC coupled input using AC voltage function.
- Signal level: 10% of range to full scale input on all ranges
- Gate time: 0.1 s or 1 period of the input signal, whichever is longer
- Input protection: 1000 V RMS on all ranges

- 1 Press Freq.
- 2 Connect the red and black test leads to the input terminal as shown in [Figure 2-5](#).
- 3 Probe the test points and read the display.

In autoranging mode, the multimeter automatically selects the appropriate range and the measurement is displayed.

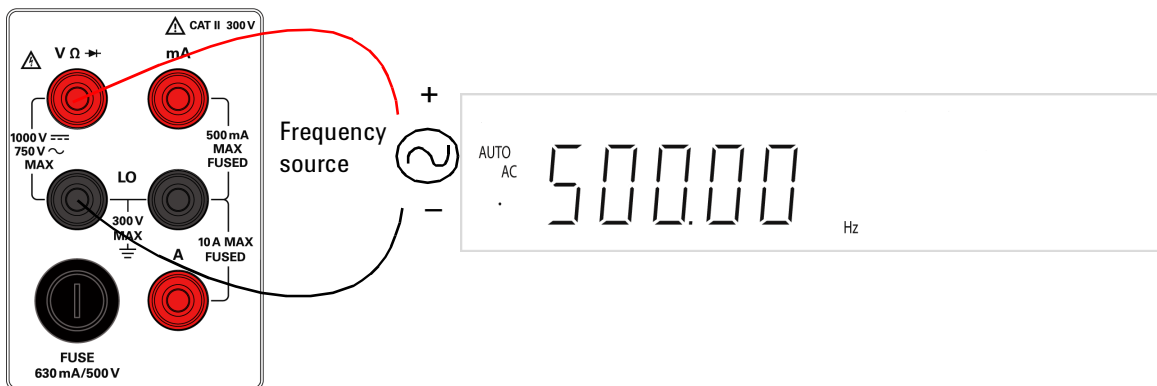

Figure 2-5 Frequency terminal connection and display

Performing Resistance/Continuity Measurements

CAUTION

Disconnect circuit power and discharge all high-voltage capacitors before measuring resistance, or testing circuit continuity, to avoid damaging the multimeter or the multimeter under test.

Measuring resistance

- Six ranges: 500.00 Ω , 5.0000 k Ω , 50.000 k Ω , 500.00 k Ω , 5.000 M Ω , 50.000 M Ω
- Measurement method: Two-wire ohms, open circuit voltage limited to <5 V
- Input protection: 500 V on all ranges

- 1 Press .
- 2 Connect the red and black test leads to the input terminal as shown in Figure 2-6.
- 3 Probe the test points (by shunting the resistor) and read the display.

In autoranging mode, the multimeter automatically selects the appropriate range and the measurement is displayed.

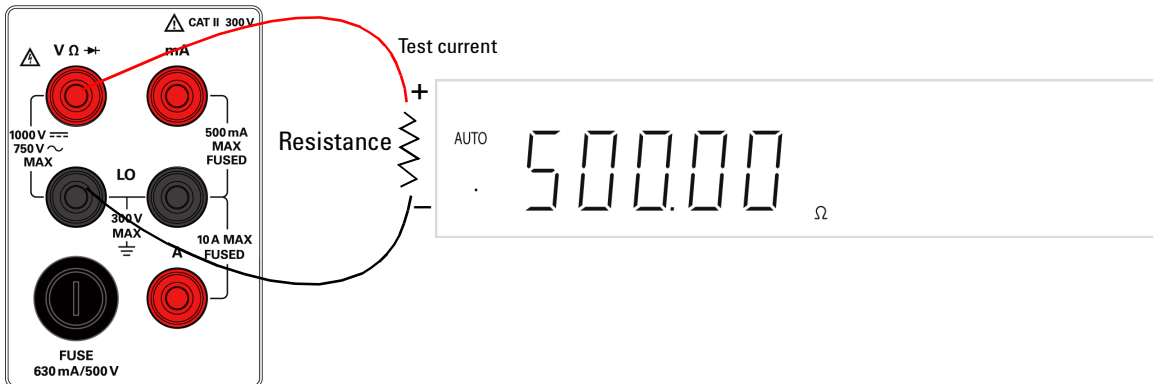

Figure 2-6 Resistance /continuity terminal connection and display

Performing Diode and Continuity Test

Testing diodes

The diode test measures the forward voltage of a semiconductor junction of approximately 0.5 mA. The beeper will emit a single beep tone when the input voltage is below +0.7 V (approximately 1.4 k Ω) and emits a continuous beep tone when the input voltage is below 50 mV (approximately 100 Ω).

NOTE

The measurement value will display **OL** (overload) when voltage measured is

- >1.2 V at slow measurement rate
- >2.5 V at medium and fast measurement rate

CAUTION

Disconnect circuit power and discharge all high-voltage capacitors before testing diodes to avoid damaging the multimeter.

- Measurement method: 0.83 mA \pm 0.2% constant current source, open-circuit voltage limited to <5 V
- Continuity threshold : 10 Ω fixed
- Input protection: 500 V DC or AC RMS

To test a diode, switch the circuit power off, and remove the diode from the circuit. Then proceed as follows:

- 1 Press  to toggle the diode and continuity function. The default function is diode measurement.
- 2 Connect the red and black test leads to the input terminal as shown in [Figure 2-7](#) and [Figure 2-8](#) respectively.
- 3 Connect the red test lead to the positive terminal (anode) of the diode and the black test lead to the negative terminal (cathode). Refer to [Figure 2-8](#).

NOTE

The cathode of a diode is indicated with a band.

4 Read the display.

5 Reverse the probes and measure the voltage across the diode again (refer to [Figure 2-8](#)). Assess the diode according to the following guidelines:

- A diode is considered good if the multimeter displays **OL** in reverse bias mode.
- A diode is considered shorted if the multimeter displays approximately 0 V in both forward and reverse bias modes, and the multimeter beeps continuously.
- A diode is considered open if the multimeter displays **OL** in both forward and reverse bias modes.

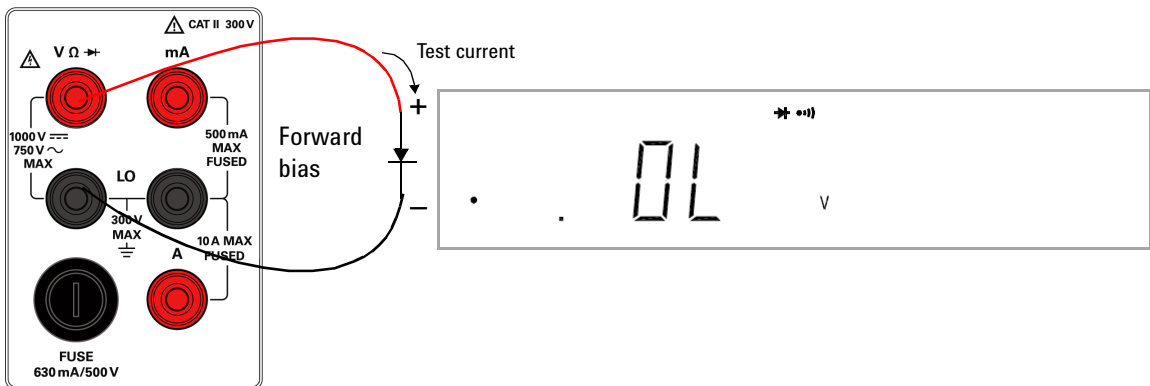

Figure 2-7 Forward-biased diode/continuity test terminal connection and display

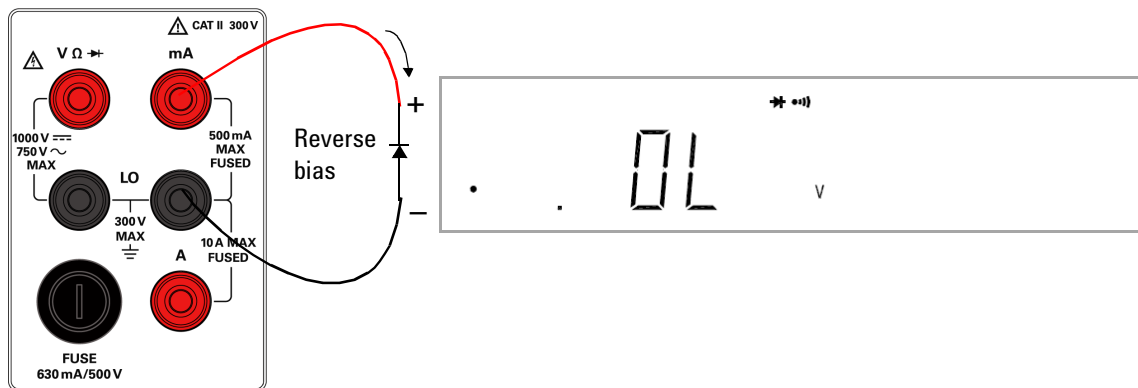

Figure 2-8 Reverse-biased diode/continuity terminal connection and display

Selecting a Range

You can allow the multimeter to select the range automatically by using autoranging, or you can select a fixed range using manual ranging. Autoranging is convenient because the multimeter automatically selects the appropriate range for sensing and displaying each measurement. However, manual ranging results in better performance, since multimeter does not have to determine which range to use for each measurement.



Selects autoranging and disable manual ranging. Press to toggle in and out of the manual ranging and autoranging.



Selects a higher range and disable autoranging.



Selects a lower range and disable autoranging.

- The range setting is synchronous for dual display for current or voltage measurement. In autoranging mode, the range setting for both the primary and secondary display are corresponding to the higher range of two displays.
- Manual ranging – If the input signal is greater than can be measured on the selected range, the multimeter will display an overload indication, OL on the primary or secondary display front panel.
- The multimeter remembers the selected ranging method (auto or manual) and the selected manual range for each measurement function.
- Autorange thresholds - The multimeter shifts ranges as follows:
 - Down range at $< 5\%$ of current range
 - Up range at $>$ full scale of current range
- [Table 2-1](#) shows the summary of range scale values respectively.







Table 2-1 Range scale value

| Measurement function | Range | Auto Ranging |
|----------------------|--|--------------|
| DCV | 500.000 mV, 5.000 V, 50.000 V, 500.000 V, 1000.00 V | ✓ |
| ACV, DCV + ACV | 500.000 mV, 5.000 V, 50.000 V, 500.000 V, 750.000 V | ✓ |
| DCI, ACI, DCI + ACI | 500.000 μ A, 5.000 mA, 50.000 mA, 500.000 mA | ✓ |
| DCI, ACI, DCI + ACI | 5.000 A, 10.000 A | ✓ [1] |
| Frequency | 500.000 Hz, 5.000 kHz, 500.000 kHz, 500.000 kHz | ✓ |
| Resistance | 500.000 Ω , 5.000 k Ω , 50.000 k Ω , 500.000 k Ω , 5.000 M Ω , 50.000 M Ω | ✓ |
| Diode test | 2.3000 V | Fixed Range |
| Continuity | 500.000, 5.000 k, 50.000 k, 500.000 k, 5.000 M, 50.000 M Ω (Continuity Mode) | ✓ |

[1] You are required to select the range manually when a signal is applied to the A terminal.

Selecting Secondary Display

To enable the secondary display mode:

- 1 Press  followed by specified function keys such as , , , , and  to enable the secondary display mode.

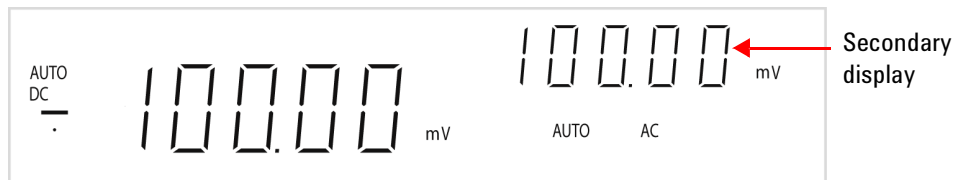



Figure 2-9 Secondary display

To disable the secondary display mode:

- 1 Press  .

The display remains in primary display mode.

Repeatedly pressing  cycles through the secondary display choices for the present math operation as shown in [Table 2-2](#).

Table 2-2 Description for dual display combination

| Primary Display | Secondary Display | | | |
|-------------------------------------|---------------------------|------------------------------|-------------------------------|-------------------------------------|
| | Default secondary display | Press secondary display once | Press secondary display twice | Press secondary display three times |
| DCV | Frequency | ACV ^[2] | dBm | - |
| ACV | Frequency | DCV ^[2] | dBm | - |
| ACV + DCV | Frequency | ACV ^[2] | DCV ^[2] | dBm |
| dBm | ACV | DVC | ACV+DCV | - |
| DCI | Frequency | ACI ^[2] | - | - |
| ACI | Frequency | DCI ^[2] | - | - |
| ACI + DCI | Hz | ACI ^[2] | DCI ^[2] | - |
| Frequency^[1] | ACV | ACI | - | - |
| COMP (Measuring Value) | HI, LO, PASS | - | - | - |
| Percentage (Measuring Value) | % | - | - | - |

^[1] a. The Frequency reading is corresponding to the current or voltage input signal respectively.

b. The Frequency measurement is always working on autoranging mode. The Buttons of AUTO, UP and DOWN are used to select the range of measuring signal.

c. If the current measurement is set before selecting Hz function, the default will show ACI first, else show ACV.

^[2] In autoranging mode, the ranges setting of both the primary and secondary display are corresponding to the higher range of two displays. Whereas in manual range, the ranges of secondary display are the same as the primary display.

Using the Setup Menu

The Setup menu allows you to customize a number of non-volatile instrument configurations. The content of the Setup menu are shown in [Table 2-3](#).

Table 2-3 Setup menu and communications parameters









| First tier menu | Description | Second tier menu | Description | Default factory setting | Available settings |
|----------------------|----------------------------|------------------|--|-------------------------|---|
| rS232 ^[1] | RS232 interface parameters | bAUd | Baud rate for remote communication with a PC (remote control). | 9600 | 9600, 4800, 2400, 1200, 600 and 300 |
| | | PArTY | Parity bit for remote communication with a PC. | None | None, odd or even |
| | | dAtA | Data bit length for remote communication with a PC. | 8 | 7 or 8 |
| | | StoP | Stop bit. | 1 | 1 or 2 |
| | | Echo | ECHO. Return a character to PC in remote communication. | OFF | ON or OFF |
| | | Print | Printer-Only. Print measured data to a PC in remote communication. | OFF | ON or OFF |
| Ref Ω | Reference impedance | | | 600 Ω | 8000 Ω , 1200 Ω , 1000 Ω , 900 Ω , 800 Ω , 600 Ω , 500 Ω , 300 Ω , 250 Ω , 150 Ω , 135 Ω , 125 Ω , 124 Ω , 110 Ω , 93 Ω , 75 Ω , 50 Ω , 16 Ω , 8 Ω , 4 Ω , 2 Ω |
| bEEP | Beeper selection | bEEP | Enable or disable beep operation. | ON | ON or OFF |
| | | bEEPF | Beep frequency. | 4096 Hz | 4096, 2048, 1024 8192 Hz |
| rHold | Refresh hold | StAtE | State. | OFF | ON or OFF |
| | | Count | Variation count. ^[2] | 300 | 100, 200, 300, 400, 500, 600, 700, 800, 900, 1000. |

^[1] For calibration use only.



^[2] Variation count is used to recognize new value will be updated once the variation of measuring value is exceeded the setting value.

Changing the Configurable Settings

The parameters in the Setup Menu can be configured by using the following procedures:

- 1 Press   to access to the Setup Menu.
- 2 Press  and  to select the desired configurable items in the first tier menu.
- 3 Press  to enter second tier menu. The original parameter is indicated in primary display.
- 4 Use  or  to select the desired parameter.
- 5 Press  to confirm the selected parameter.
- 6 Press  to quit from the tier menu and press again to quit from the Setup menu.
- 7 The configuration settings is saved and main display is displayed.

Selecting Local Operation Mode

Press   to return the operation from remote mode to local mode.

Operating Math Functions

Table 2-4 presents a summary of the math operations that can be used with each measurement function.

Table 2-4 Math operations for different measurement functions

| Measurement Function | Allowed math operations | | | | | | |
|----------------------|-------------------------|-----|-----|-----|------|------|---|
| | dBm | Rel | Min | Max | Comp | Hold | % |
| DCV | ✓ | ✓ | ✓ | ✓ | ✓ | ✓ | ✓ |
| DCI | - | ✓ | ✓ | ✓ | ✓ | ✓ | ✓ |
| Resistance | - | - | ✓ | ✓ | ✓ | ✓ | ✓ |
| ACV | ✓ | ✓ | ✓ | ✓ | ✓ | ✓ | ✓ |
| ACI | - | ✓ | ✓ | ✓ | ✓ | ✓ | ✓ |
| Frequency | - | ✓ | ✓ | ✓ | ✓ | ✓ | ✓ |
| Diode/Continuity | - | - | ✓ | ✓ | ✓ | ✓ | ✓ |

- All math operations can be toggled on and off by selecting the same math operation.
- Only one math operation can be turned-on at a time. When selecting another math operation when one is already on, you are required to turn off the first operation and then turn-on the second math operation.
- All math operations are automatically turned-off when changing the measurement functions.
- Range changing is allowed for all math operations.

dBm

The logarithmic dBm (decibels relative to one milliwatt) scale is often used in RF signal measurements. The multimeter's dBm operation takes a measurement and calculates the power delivered to a reference impedance (typically 50, 75 or 600 Ω). The formula used for conversion from the voltage reading is:

$$dBm = 10 \times \text{Log}_{10} [1000 \times (\text{Reading}^2 / \text{reference impedance})]$$

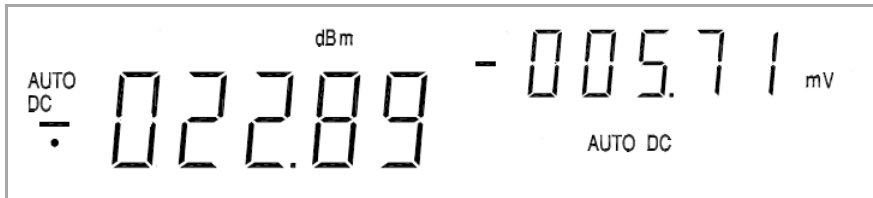







Figure 2-10 Typical dBm operation display

The default reference impedance value is 600 Ω. You can select the following 21 reference impedance values:

2 Ω, 4 Ω, 8 Ω, 16 Ω, 50 Ω, 75 Ω, 93 Ω, 110 Ω, 124 Ω, 125 Ω, 135 Ω, 150 Ω, 250 Ω, 300 Ω, 500 Ω, 600 Ω, 800 Ω, 900 Ω, 1000 Ω, 1200 Ω, 8000 Ω.

The dBm operation can be applied to DCV, ACV and DCV + ACV measurement functions only. The multimeter displays the dBm modifier on the primary display and displays the reference impedance selection on the secondary display.

Procedure 1

- 1 Press   to enter dBm modifier mode.
- 2 Use  and  to select the desired reference impedance.
- 3 Press   to enable the dBm operation and read the display.

Rel

When making Rel (relative) measurements, each reading is the difference between a stored relative value and the input signal. For example, this feature can be used to make more accurate resistance measurements by nulling the test lead resistance.

After you enable the Rel operation, the multimeter stores the next reading as a Rel # (reference value) and immediately displays on the primary display:

$$\text{Primary Display} = \text{Reading} - \text{Rel \#}$$

When the Rel operation is enabled in autoranging mode, enabling the Comp or Percentage operation will disable the Rel operation.

Procedure

- 1 Press  to exit the relative mode.

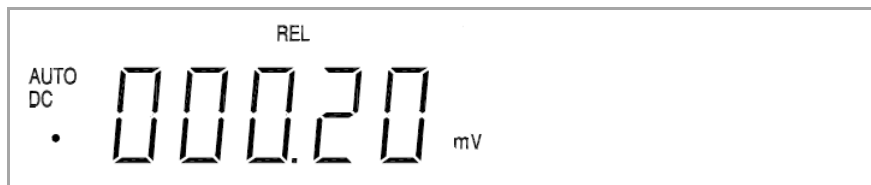

Figure 2-11 Typical Rel operation display

MinMax

The MinMax (Minimum/Maximum) operation stores the minimum and maximum values of reading during a series of measurements.

When enabled, the MinMax operation turns on the **MINMAX** annunciator and begins accumulating various statistics of the readings being displayed.

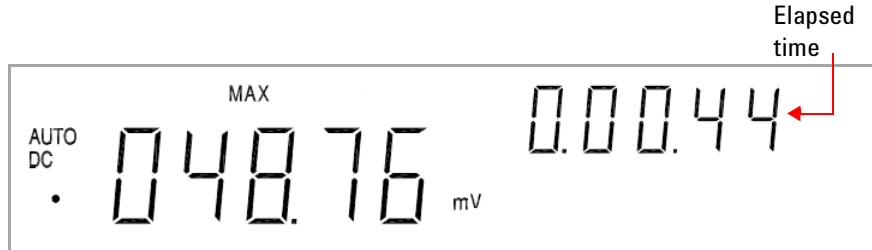

Figure 2-12 Typical Max operation display

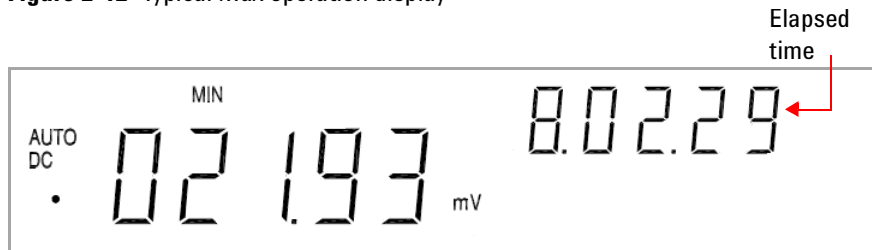

Figure 2-13 Typical Min operation display

Each time a new minimum or maximum value is stored, the multimeter beeps once (if the beeper is enabled) and briefly turns on the appropriate **MAX** or **MIN** annunciator.





Accumulated statistics are:

- **MAX**—maximum reading since MinMax was enabled
- **MIN**—minimum reading since MinMax was enabled
- **MINMAX**—actual readings

The elapsed time is recorded when the MinMax operation is selected. The elapsed time is shown on the secondary display with **HH.MM.SS**.

- **HH** is 0-19 hours
- **MM** is 0-59 minutes
- **SS** is 0-59 seconds

Procedure

- 1 Press  to enable MinMax operation.
- 2 Press  continuously until the desired operation appear. The MinMax operation will display **MINMAX > MAX > MIN > MINMAX** in sequence when this key is press continuously.
- 3 Press   to disable the MinMax operation.



Comp

The Comp (compare) operation allows you to perform pass/fail testing against specified upper and lower limits. You can set the upper and lower limits to any value between 0 and $\pm 100\%$ of the highest range for the present operation.

















Figure 2-14 Typical Comp operation display

When enabled, the actual readings are shown in primary display and the comparison results such as **HI**, **LO** or **PASS** is shown in secondary display.

- You should specify the upper limit to always be a more positive number than the lower limit. The initial factory setting for each limit is 0.
- The secondary display shows **PASS** when readings are within the specified limits. The secondary display shows **HI** when the reading is outside the high limit and **LO** when the reading is outside the low limit.
- When the beeper is ON (see [“Using the Setup Menu”](#) on page 34), the beeper beeps three tones on the transition from **PASS** to **HI** or **LO**. When transitioning from **HI** or **LO** to **PASS** it will only beep once.
- Press   to enable Comp operation.

Procedure

- 1 Press   to enter the upper limit setup mode. The upper limit is shown on primary display while the **HI** annunciator is shown on secondary display.
- 2 Use , , , and  to modify the upper limit.
- 3 Press  to store the specified **HI** limit value.
- 4 Press   to enter the lower limit setup mode. The lower limit is shown on primary display while the **LO** annunciator is shown on secondary display.
- 5 Use , , , and  to modify the lower limit.
- 6 Press  to store the specified **LO** limit value.
- 7 Press  to disable the Comp operation or exit.

Hold

The reading hold feature allows you to capture and hold a reading on the front panel display. When enabled, the Hold operation turns on the **HOLD** annunciator and hold the reading.

Procedure

- 1 Press  to hold the reading on the display.













Figure 2-15 Typical Hold operation display

Refresh Hold

The refresh hold operation allows you to take measurement in dangerous or difficult measuring field and you could not look at the display. This operation will update the hold value with a new measurement value automatically, and thus reminds you with a beep.

Procedure

- 1 Press   to access to the Setup menu.
- 2 Use  and  to select the **rHold**.
- 3 Press  to enter the second tier menu. Use  and  to set the state to ON.
- 4 Press  to confirm.

- 5 Press  twice quit the Setup menu.
- 6 Press  to select refresh hold mode. The present value will be held and the **HOLD** will be lit. The multimeter is now ready to hold a new measurement value once the variation of measuring value exceeds the setting of the variation count. The **HOLD** annunciator will be blinking continuously.
- 7 When the refresh hold is not in use, repeat step 1 to step 4 to turn off the refresh hold's state.

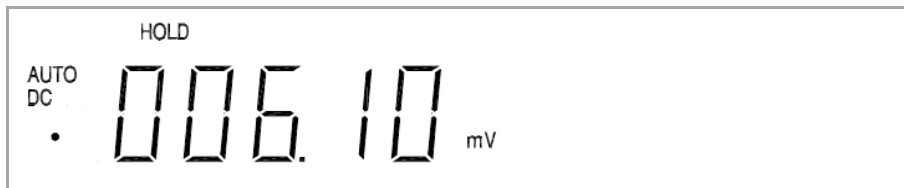

Figure 2-16 Typical refresh hold operation display

NOTE

- For voltage and current measurements, the held value will not be updated when the reading below 500 counts.
- For resistance and diode measurements, the held value will not be updated of the reading at OL or open state.

Percentage (%)

This operation allows you to transfer the measurement value with a proportional percentage display. You can set the upper limit (HI) and lower limit (LO) to any value between 0 and ±100% of the highest range for the present function.

The percentage operation calculates and display the measurement value using the equation below:

$$\text{Percentage (\%)} = [\text{Measurement value} - \text{LO}/(\text{HI} - \text{LO})] \times 100\%$$

When the HI limit is equal to LO limit, the percentage operation will use the equation as below:

$$\text{Percentage (\%)} = [(\text{Measurement value} - \text{HI})/\text{HI}] \times 100\%$$

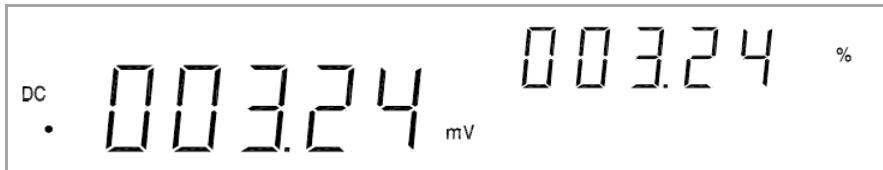



















Figure 2-17 Typical percentage (%) operation display

When enabled, the actual readings are shown in primary display and the percentage's result is shown in secondary display.

- The secondary display shows **OL** when readings exceed the maximum display of 999.99%.
- When autoranging is enabled, this operation will be used to lock the current range.

Procedure

- 1 Press   to enter the upper limit setup mode. The upper limit is shown on primary display while the **HI** annunciator is shown on secondary display.
- 2 Use  ,  ,  , and  to modify the upper limit.
- 3 Press  to store the specified **HI** limit value.
- 4 Press   to enter the lower limit setup mode. The lower limit is shown on primary display while the **LO** annunciator is shown on secondary display.
- 5 Use  ,  ,  , and  to modify the lower limit.
- 6 Press  to store the specified **LO** limit value.
- 7 Press   to enable percentage operation.
- 8 Press   to disable percentage operation.

Trigger Mode









This multimeter has two types of trigger mode.

- Internal – triggers measurements continuously.
- External – triggers a measurement only when a direction is given.

The external trigger is used with a delay settling that has been set by the multimeter automatically. The amount of trigger delay varies depending on different function. When external trigger is enabled, the multimeter determines the range for the primary display based on the input at that time.

Autoranging response time is required before a reading is displayed when you change the input after a trigger is received.

Procedure

- 1 Press   to enter trigger mode and standby condition. The annunciator of **TRIG** will be lit and display is indicated with “-----”.
- 2 Press  to get a new value. After a measuring, then the result will be indicated and held on display.
- 3 Press  to get a new value again.
- 4 Press ,  or  to select autoranging or manual range as necessary.
- 5 Press   to disable external trigger operation mode.

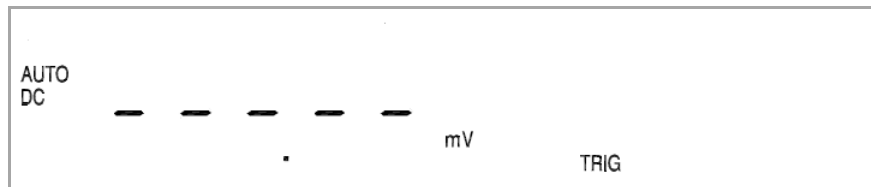

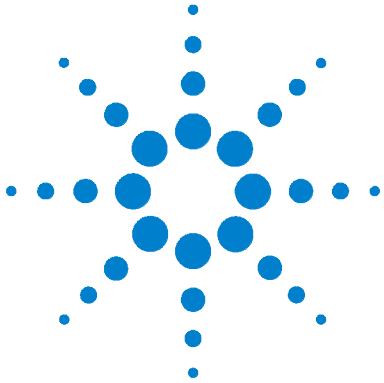

Figure 2-18 Typical Trigger mode display

NOTE

- All math operations will be disabled when external trigger is enabled.
- Press   may disable external trigger also.
- Both the primary and secondary display will only appear when frequency operation is selected in trigger mode.



3 Measurement Tutorial

| | |
|---|----|
| Applications for Using Dual Display | 50 |
| Dual Display Operation Examples | 51 |
| Measure DC Voltage and AC Ripple on a Rectification Circuit | 51 |
| Measure AC and DC Current on a Rectification Circuit | 52 |
| Measuring AC Voltage and Frequency on an AC Circuit | 53 |
| Measuring Resistance | 54 |
| Measure True RMS AC + DC | 55 |

This chapter describes the advanced features and applications for effective operation of the multimeter.



Applications for Using Dual Display

The dual display feature in the multimeter can be used to enhance test and measurement capabilities. See [Table 3-1](#) for the available combinations and application when using dual display.

Table 3-1 Typical combinations and applications when using dual display

| No. | Primary display | Secondary display | Applications |
|-----|-----------------|--------------------|--|
| 1 | DCV | ACV | • Test DC to AC or AC to DC converter circuit. |
| 2 | ACV + DCV | DCV | • Measure DC level and AC ripple of power supply. |
| 3 | ACV | Frequency | • Measuring AC frequency response of amplifier circuit. |
| 4 | ACI | Frequency | • Adjusting AC motor control. |
| 5 | DCI | ACI | • Measuring AC ripple and DC current of power supply. |
| 6 | ACI + DCI | DCI | • Measuring current dissipation for power supply analysis. |
| 7 | dBm | Reference Ω | • Setting dB reference impedance and show dBm. |
| 8 | dBm | DCV | • Indicating DC voltage and dBm. |
| 9 | dBm | ACV | • Indicating AC voltage and dBm. |

Dual Display Operation Examples

This section describe some practical operations when using dual display feature.

Measure DC Voltage and AC Ripple on a Rectification Circuit

A single measurement for both DC voltage and AC ripple can be displayed through both display while testing a rectifier circuit.

- 1 Connect the red and black test leads to the input terminal and probe the test points as shown in [Figure 3-1](#).

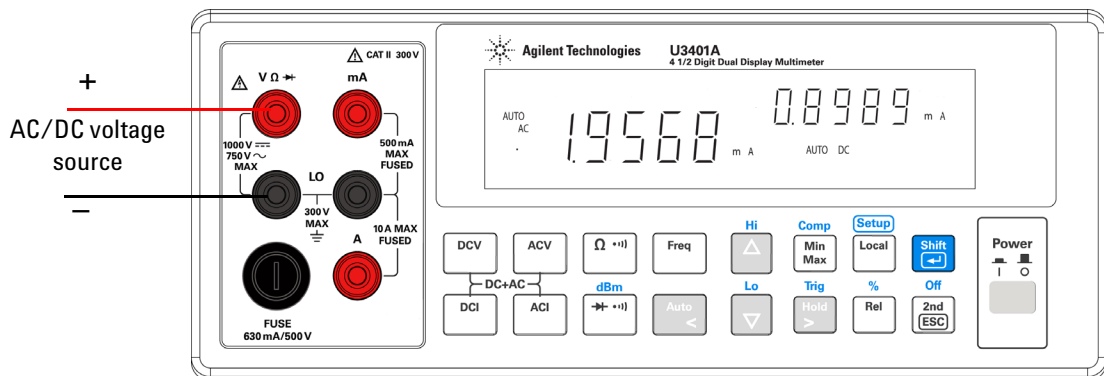

Figure 3-1 Connection terminal when measuring DC voltage and AC ripple

- 2 Press to select DC voltage measurement in primary display.
 - 3 Press to select AC voltage measurement for secondary display.
 - 4 Press . Use and to select autoranging or manual range for secondary display.
- Press to disable the secondary display.
 - Press to select the suitable range if DCV+ACV ripple is above the scale of the current range.

NOTE

Measure AC and DC Current on a Rectification Circuit

A single measurement for both AC current and DC current can be displayed through both display while testing a rectifier circuit.

WARNING

- Make sure you select the correct input terminal according to the input range used.
- Do not apply current exceeding specified range to input terminals of mA or A.

- 1 Connect the red and black test leads to the input terminal and probe the test points as shown in Figure 3-2.

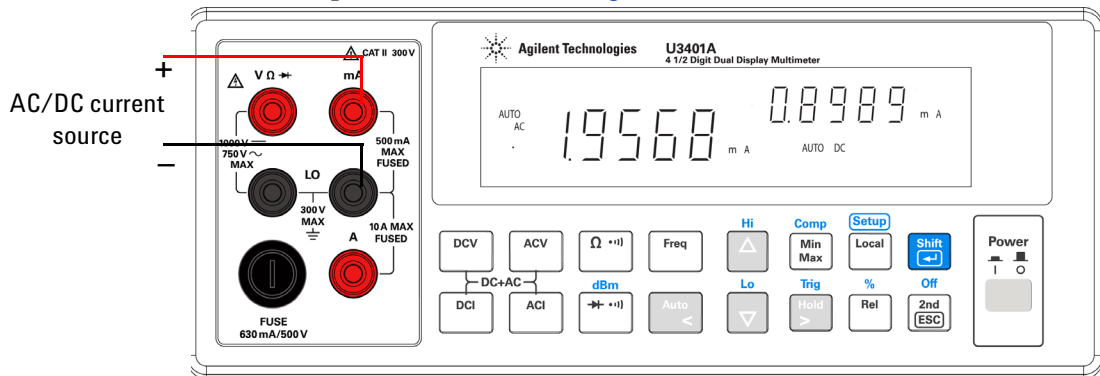









Figure 3-2 Connection terminal when using DC current and AC ripple

- 2 Press  to select AC current measurement for primary display.
- 3 Press  to enable the DC current measurement for secondary display.
- 4 Press ,  or  to select autoranging or manual range for secondary display.

NOTE

Press   to disable the secondary display.

Measuring AC Voltage and Frequency on an AC Circuit

A single measurement for both AC voltage and frequency can be displayed through both display while testing a rectifier circuit.

- 1 Connect the red and black test leads to the input terminal and probe the test points as shown in [Figure 3-3](#).

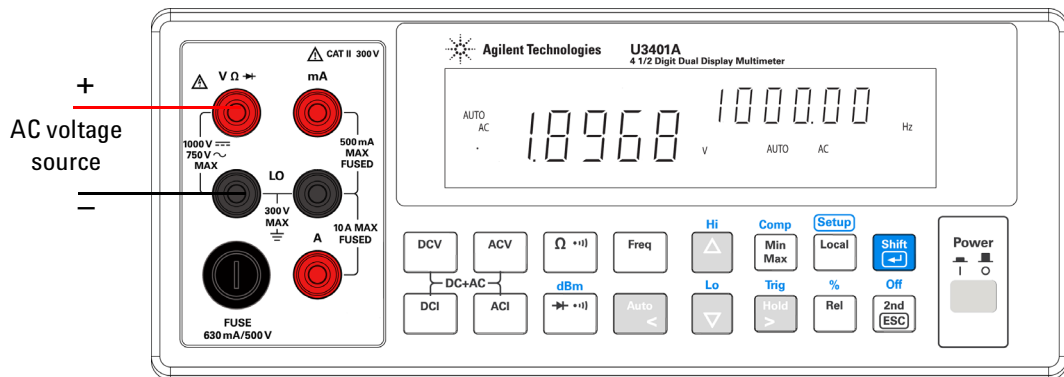









Figure 3-3 Connection terminal when measuring AC Voltage and Frequency

- 2 Press  to select AC voltage measurement for primary display.
- 3 Press  to select frequency measurement for secondary display.
- 4 Press  ,  or  to select autoranging or manual range for secondary display.

NOTE

- Press   to disable the secondary display.

Measuring Resistance

A single measurement for both DC voltage and frequency can be displayed through both display while testing a rectifier circuit.

WARNING

Do not apply voltage exceeding 500 V PEAK between V Ω \rightarrow and COM input terminals.

- 1 Connect a resistor under test to V Ω \rightarrow and LO input terminals as shown in [Figure 3-4](#).

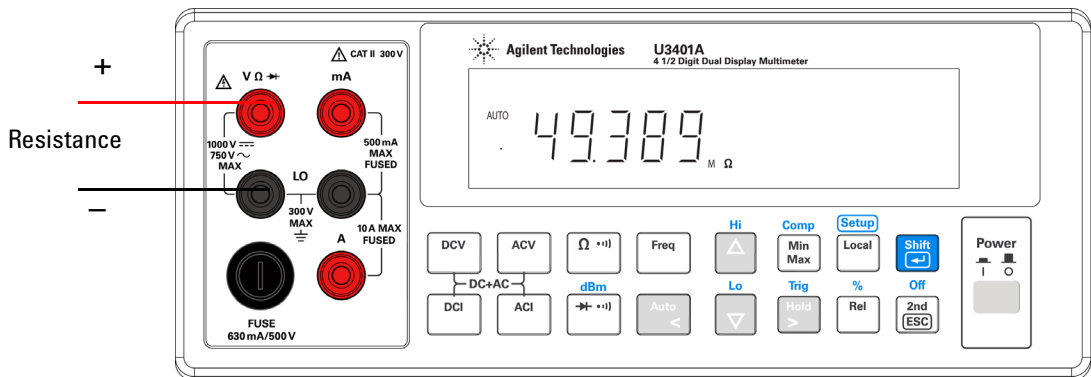

Figure 3-4 Connection terminal when measuring Resistance

- 2 Press to select resistance measurement.
- 3 Press . Use and to select autoranging or manual range for primary display.

Measure True RMS AC + DC

The multimeter can measure the true RMS of AC voltage and AC current.

- 1 Press , and or and simultaneously. The multimeter will measure the DC and AC signals alternatively, calculate and display the AC+DC RMS value using the equation below:

$$\text{AC+DC (RMS)} = \sqrt{\text{DC}^2 + \text{AC}^2}$$

NOTE

When AC+DC voltage measurement is selected, the DCV input impedance is paralleled with the AC coupled 1.1 M Ω AC divider.

3 Measurement Tutorial



4 Performance Test

| | |
|---|----|
| Calibration Overview | 58 |
| Agilent Technologies Calibration Services | 58 |
| Calibration Interval | 58 |
| Recommended Test Equipment | 59 |
| Test Considerations | 60 |
| Input Connections | 60 |
| Performance Verification Tests Overview | 61 |
| Performance Verification Tests | 61 |
| DC Voltage Verification Test | 61 |
| DC Current Verification Test | 62 |
| Resistance Verification Test | 64 |
| Diode Verification Test | 65 |
| Frequency Verification Test | 65 |
| AC Voltage Verification Test | 66 |
| AC Current Verification Test | 67 |

This chapter contains performance test procedures and calibration procedures. The performance tests procedures allow you to verify that the multimeter is operating within its published specifications.

WARNING

Shock hazard. Only service-trained personnel who are aware of the hazards involved should perform the procedures in this chapter. To avoid electrical shock and personal injury, make sure to read and follow all test equipment safety instructions.

Use only completely electrically insulated test lead sets with connectors that prevent contact with test voltages.



Calibration Overview

NOTE

Make sure you have read “[Test Considerations](#)” on page 60 before calibrating the instrument.

Agilent Technologies Calibration Services

When your instrument is due for calibration, contact your local Agilent Service Center for a low-cost recalibration. The U3401A is supported on automated calibration systems, which allow Agilent to provide this service at competitive prices.

Calibration Interval

A one-year interval is adequate for most applications. Accuracy specifications are warranted only if adjustment is made at regular calibration intervals. Accuracy specifications are not warranted beyond the one-year calibration interval. Agilent does not recommend extending calibration intervals beyond two years for any application. When an adjustment is required, contact your local Agilent Service Center.

Recommended Test Equipment

The test equipments recommended for the performance verification procedures are listed below. If the exact instrument is not available, substitute calibration standards of equivalent accuracy.

A suggested alternate method would be to use the Agilent 3458A 8½ -digit digital multimeter to measure less accurate yet stable sources. The output value measured from the source can be entered into the instrument as the target calibration value.

Table 4-1 Recommended test equipments

| Application | Recommended Equipment | Recommended Accuracy Requirements |
|------------------|---|-----------------------------------|
| Zero calibration | Shorting plug—Dual banana plug with copper wire short between the two terminals | |
| DC voltage | Fluke 5520A | < 1/5 instrument 1 year spec |
| DC current | Fluke 5520A | < 1/5 instrument 1 year spec |
| Resistance | Fluke 5520A | < 1/5 instrument 1 year spec |
| AC voltage | Fluke 5520A | < 1/5 instrument 1 year spec |
| AC current | Fluke 5520A | < 1/5 instrument 1 year spec |
| Frequency | Fluke 5520A | < 1/5 instrument 1 year spec |
| Diode | Fluke 5520A | < 1/5 instrument 1 year spec |

Test Considerations

For optimum performance, all procedures should comply with the following recommendations:

- Ensure that the calibration ambient temperature is stable and between 18°C and 28°C. Ideally the calibration should be performed at 23°C ±1°C.
- Ensure ambient relative humidity is less than 80%.
- Allow a one-hour warm-up period with a Shorting Plug connected to the Hi and Lo input terminals.
- Use shielded twisted pair Teflon-insulated cables to reduce settling and noise errors. Keep the input cables as short as possible.
- Connect the input cable shields to earth ground. Connect the calibrator Lo source to earth ground at the calibrator except where noted in the procedures. It is important that the Lo to earth ground connection be made at only one place in the circuit to avoid ground loops.

Because the instrument is capable of making very accurate measurements, you must take special care to ensure that the calibration standards and test procedures used do not introduce additional errors. Ideally, the standards used to verify and adjust the instrument should be an order of magnitude more accurate than each instrument range full-scale error specification.

Input Connections

Test connections to the instrument are best accomplished using the dual banana plug with copper wire short between two terminals for low-thermal offset measurement. Shielded, twisted-pair, Teflon interconnect cables of minimum length are recommended between the calibrator and the multimeter. Cable shields should be earth ground referenced. This configuration is recommended for optimal noises and settling time performance during calibration.

Performance Verification Tests Overview

Performance verification tests is an extensive set of tests that are recommended as an acceptance test when you first receive the instrument.

Use the performance verification test to verify the measurement performance of the instrument. The performance verification test uses the instrument's specifications listed in [Chapter 6](#) "Specifications and Characteristics".

Performance Verification Tests

The performance verification test is recommended as acceptance tests when you first received the instrument. The acceptance test results should be compared against the one-year test limits. After acceptance, you should repeat the performance verification tests at every calibration interval.

If the instrument fails performance verification, adjustment or repair is required. Contact your local Agilent Service Center for details.

NOTE

Make sure you have read "[Test Considerations](#)" on page 60 before doing the performance verification tests.

This test checks the full-scale reading accuracy of the instrument.

DC Voltage Verification Test

- 1 Connect the calibrator to the front panel Hi and Lo input terminals.
- 2 Select each function and range in the order shown in [Table 4-2](#). Provide the input shown in [Table 4-2](#)
- 3 Make a measurement and observe the result. Compare measurement results to the appropriate test limits shown in the [Table 4-2](#). (Be certain to allow for appropriate source settling when using the Fluke 5520A).

Table 4-2 DC voltage verification test

| Function | Input | Range | Error from nominal one year |
|------------|-----------|--------|-----------------------------|
| DC voltage | 0.00 V | 500 mV | ±40 µV |
| | 0.0000 V | 5 V | ±0.4 mV |
| | 0.000 V | 50 V | ±4 mV |
| | 0.00 V | 500 V | ±40 mV |
| | 0.0 V | 1000 V | ±400 mV |
| | 450.00 mV | 500 mV | ±130 µV |
| | 4.5000 V | 5 V | ±1.3 mV |
| | 45.000 V | 50 V | ±13 mV |
| | 450.00 V | 500 V | ±130 mV |
| | 900.0 V | 1000 V | ±500 mV |

CAUTION

Set the calibrator output to 0 V before disconnecting it from the multimeter input terminals.

DC Current Verification Test

- 1 Connect the calibrator to the front panel Hi and Lo input connectors.
- 2 Select each function and range in the order shown in [Table 4-3](#). Provide the input shown in [Table 4-3](#).
- 3 Make a measurement and observe the result. Compare measurement results to the appropriate test limits shown in [Table 4-3](#). (Be certain to allow for appropriate source settling when using the Fluke 5520A).

Table 4-3 DC current verification test

| Function | Input | Range | Error from nominal one year |
|------------|----------------|-------------|-----------------------------|
| DC current | 0.00 μ A | 500 μ A | ± 0.05 μ A |
| | 0.0000 mA | 5 mA | ± 0.4 μ A |
| | 0.000 mA | 50 mA | ± 4 μ A |
| | 0.00 mA | 500 mA | ± 40 μ A |
| | 450.00 μ A | 500 μ A | ± 0.27 μ A |
| | 4.5000 mA | 5 mA | ± 2.6 μ A |
| | 45.000 mA | 50 mA | ± 26 μ A |
| | 450.00 mA | 500 mA | ± 0.26 mA |
| | 0.0000 A | 5 A | ± 0.5 mA |
| | 0.000 A | 10 A | ± 5 mA |
| | 4.5000 A | 5 A | ± 11.7 mA |
| | 9.000 A | 10 A | ± 27 mA |

CAUTION

Connect calibrator to multimeter's A and Lo terminals before applying 10 A.

Resistance Verification Test

Configuration: 2-Wire Ω

- 1 Select the resistance function.
- 2 Select each range in the order shown in Table 4-4. Provide the resistance value indicated. Compare measurement results to the appropriate test limits shown in Table 4-4. (Be certain to allow for appropriate source settling).

Table 4-4 2-wire Ω verification test

| Function | Input | Range | Error from nominal one year |
|-----------------|-------------------|----------------|---------------------------------|
| 2-wire Ω | 0.00 Ω | 500 Ω | $\pm 50 \text{ m}\Omega^{[1]}$ |
| | 0.0000 k Ω | 5 k Ω | $\pm 0.3 \Omega^{[1]}$ |
| | 0.000 k Ω | 50 k Ω | $\pm 3 \Omega$ |
| | 0.00 k Ω | 500 k Ω | $\pm 30 \Omega$ |
| | 0.0000 M Ω | 5 M Ω | $\pm 300 \Omega$ |
| | 0.000 M Ω | 50 M Ω | $\pm 3 \text{ k}\Omega$ |
| | 450.00 Ω | 500 Ω | $\pm 500 \text{ m}\Omega^{[1]}$ |
| | 4.5000 k Ω | 5 k Ω | $\pm 4.8 \Omega^{[1]}$ |
| | 45.000 k Ω | 50 k Ω | $\pm 48 \Omega$ |
| | 450.00 k Ω | 500 k Ω | $\pm 480 \Omega$ |
| | 4.5000 M Ω | 5 M Ω | $\pm 4.8 \text{ k}\Omega$ |
| | 30.000 M Ω | 50 M Ω | $\pm 93 \text{ k}\Omega$ |

^[1] Specifications are for 2-wire ohms function using the Rel operation enabled to eliminate lead resistance.

Diode Verification Test

Configuration: Diode

- 1 Connect the calibrator to the front panel Hi and Lo input terminals.
- 2 Select each function and range in the order shown in [Table 4-5](#). Provide the input shown in [Table 4-5](#).
- 3 Make a measurement and observe the result. Compare measurement results to the appropriate test limits shown in [Table 4-5](#). (Be certain to allow for appropriate source settling when using the Fluke 5520A).

Table 4-5 Diode verification test

| Function | Voltage | Range | Error from nominal one year |
|----------|----------|-------|-----------------------------|
| Diode | 1.0000 V | 2.3 V | ±1 mV |
| | 2.0000 V | 2.3 V | ±1.5 mV |

Frequency Verification Test

Configuration: Frequency

- 1 Select the frequency function.
- 2 Select each range in the order shown in [Table 4-6](#). Provide the input voltage and frequency indicated. Compare measurement results to the appropriate test limits shown in [Table 4-6](#). (Be certain to allow for appropriate source settling).

Table 4-6 Frequency verification test

| Function | Voltage | Input frequency | Range | Error from nominal one year |
|-----------|---------|-----------------|-------|-----------------------------|
| Frequency | 2 V | 4.5 kHz | 5 kHz | ±0.7 Hz |

AC Voltage Verification Test

Configuration: AC volts

- 1 Select the AC voltage function.
- 2 Select each range in the order shown in [Table 4-7](#). Provide the indicated input voltage and frequency. Compare measurement results to the appropriate test limits shown in [Table 4-7](#). (Be certain to allow for appropriate source settling).

Table 4-7 AC volts verification test

| Function | V RMS | Input frequency | Range | Error from nominal one year |
|------------|-----------|-----------------|--------|-----------------------------|
| AC voltage | 50.00 mV | 1 kHz | 500 mV | ±650 μ V |
| | 450.00 mV | 1 kHz | 500 mV | ±2.65 mV |
| | 0.5000 V | 1 kHz | 5 V | ±3.2 mV |
| | 4.5000 V | 1 kHz | 5 V | ±17.2 mV |
| | 5.000 V | 1 kHz | 50 V | ±32 mV |
| | 45.000 V | 1 kHz | 50 V | ±172 mV |
| | 50.00 V | 1 kHz | 500 V | ±400 mV |
| | 450.00 V | 1 kHz | 500 V | ±2.4 V |
| | 75.0 V | 1 kHz | 750 V | ±1.8 V |
| | 675.0 V | 1 kHz | 750 V | ±4.8 V |

CAUTION

Set the calibrator output to 0 V before disconnecting it from the multimeter input terminals.

AC Current Verification Test

Configuration: AC current

- 1 Select the AC current function.
- 2 Select each range in the order shown in [Table 4-8](#). Provide the input current and frequency indicated. Compare measurement results to the appropriate test limits shown in [Table 4-8](#). (Be certain to allow for appropriate source settling).

Table 4-8 AC current verification test

| Function | Current | Input frequency | Range | Error from nominal one year |
|------------|----------------|-----------------|-------------|-----------------------------|
| AC current | 50.00 μ A | 1 kHz | 500 μ A | ± 0.45 μ A |
| | 450.00 μ A | 1 kHz | 500 μ A | ± 2.45 μ A |
| | 0.5000 mA | 1 kHz | 5 mA | ± 4.5 μ A |
| | 4.5000 mA | 1 kHz | 5 mA | ± 24.5 μ A |
| | 5.000 mA | 1 kHz | 50 mA | ± 45 μ A |
| | 45.000 mA | 1 kHz | 50 mA | ± 0.245 mA |
| | 50.00 mA | 1 kHz | 500 mA | ± 0.45 mA |
| | 450.00 mA | 1 kHz | 500 mA | ± 2.45 mA |
| | 0.5000 A | 1 kHz | 5 A | ± 5.5 mA |
| | 1.000 A | 1 kHz | 10 A | ± 35 mA |
| | 4.5000 A | 1 kHz | 5 A | ± 25.5 mA |
| 9.000 A | 1 kHz | 10 A | ± 75 mA | |

4 Performance Test

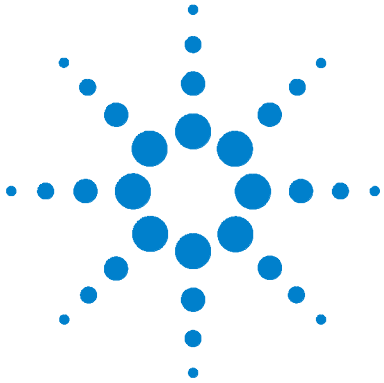

5 Disassembly and Repair

| | |
|---|----|
| Operating Checklist | 70 |
| Types of Service Available | 71 |
| Repackaging for Shipment | 72 |
| Cleaning | 72 |
| To Replace the Power Line Fuse | 73 |
| To Replace a Current Input Fuse | 74 |
| Electrostatic Discharge (ESD) Precautions | 74 |
| Mechanical Disassembly | 75 |
| Replaceable Parts | 81 |
| Rack Mounting | 82 |

This chapter will help you troubleshoot a faulty multimeter. It describes how to disassemble the multimeter, how to obtain repair services, and lists the replaceable parts.



Operating Checklist

Before returning your multimeter to Agilent for service or repair check the following items:

Is the multimeter inoperative?

- ✓ Verify the power line voltage setting.
- ✓ Verify the power line fuse is installed.
- ✓ Verify that the power cord is connected to the multimeter and to AC line power.
- ✓ Verify the front panel power switch is depressed.

See [page 73](#)

Is the mutimeter's current input inoperative?

- ✓ Verify the current input fuse.

Types of Service Available

If your instrument fails during the warranty period, Agilent Technologies will repair or replace it under the terms of your warranty. After your warranty expires, Agilent offers repair services at competitive prices.

Extended Service Contracts

Many Agilent products are available with optional service contracts that extend the *covered period* after the standard warranty expires. If you have such a service contract and your instrument fails during the covered period, Agilent Technologies will repair or replace it in accordance with the contract.

Obtaining Repair Service (Worldwide)

To obtain service for your instrument (in-warranty, under service contract, or post-warranty), contact your nearest Agilent Technologies Service Center. They will arrange to have your instrument repaired or replaced, and can provide warranty or repair-cost information where applicable.

To obtain warranty, service, or technical support information you can contact Agilent Technologies at one of the following telephone numbers:

In the United States: (800) 829-4444

In Europe: 31 20 547 2111

In Japan: 0120-421-345

Or use our Web link for information on contacting Agilent worldwide:

www.agilent.com/find/assist

Or contact your Agilent Technologies representative.

Before shipping your instrument, ask the Agilent Technologies Service Center to provide shipping instructions, including what components to ship. Agilent recommends that you retain the original shipping carton for use in such shipments.

Repackaging for Shipment

If the instrument is to be shipped to Agilent for service or repair, be sure to:

- Attach a tag to the unit identifying the owner and indicating the required service or repair. Include the model number and full serial number.
- Place the unit in its original container with appropriate packaging material for shipping.
- Secure the container with strong tape or metal bands.
- If the original shipping container is not available, place your instrument in a container which will ensure at least 4 inches of compressible packaging material around all sides for the instrument. Use static-free packaging materials to avoid additional damage to your instrument.

Agilent suggests that you always insure shipments.

Cleaning

Clean the outside of the multimeter with a soft, lint-free, slightly dampened cloth. Do not use detergent. Disassembly is not required or recommended for cleaning.

To Replace the Power Line Fuse

The power line fuse is located within the multimeter's fuse-holder assembly on the rear panel. The multimeter is shipped from the factory with a power-line fuse installed (according to country of destination). See [Table 5-1](#). If you determine that the fuse is faulty, replace it with one of the same size and rating.

Table 5-1 Type of supplied fuse (according to country of destination)

| Type of fuse(time-lag,low breaking fuse) | Input line voltage | Part number |
|--|--------------------|-----------------|
| 0.25A, 250V, 5x20 mm | 100 V to 120 V | A02-62-25592-3U |
| 0.125A, 250V, 5x20 mm | 220 V to 240 V | A02-62-25648-1U |

1 Disconnect the power cord. Depress tab 1 and 2 and pull the fuse holder from rear panel.

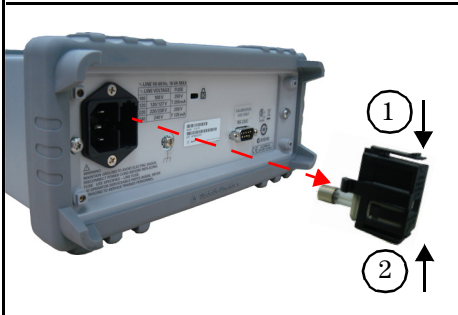

2 Remove the line voltage selector from fuse

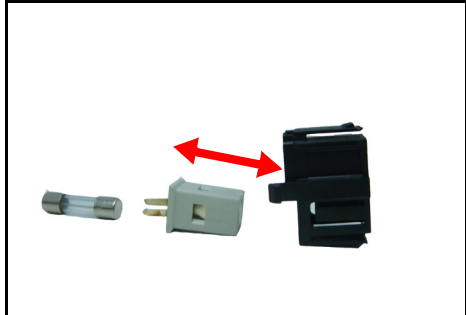

2 Rotate the line voltage selector and reinstall it back, so that the correct voltage appears in the fuse holder window.

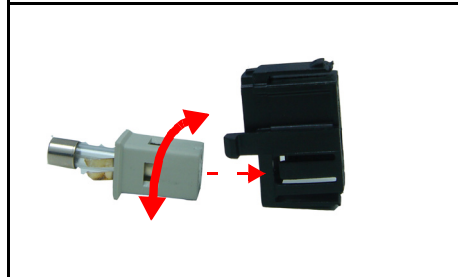

4 Replace fuse holder assembly in rear panel.



To Replace a Current Input Fuse

Both the mA and the A current input terminals are fuse protected. The fuse for the mA input terminal is located on the front panel (see [page 16](#)). The fuse is a 0.63 mA, 500 V fuse, Agilent part number 2110-1432. If you determine that the fuse is faulty, replace it with one of the same size and rating.

The fuse for the A current input terminal is located inside the multimeter (see [page 79](#)) and requires partial disassembly of the multimeter. The fuse is a 25 A, 440 V fast-acting fuse, Agilent part number 2110-1431. If you determine that the fuse is faulty, replace it with one of the same size and rating.

Electrostatic Discharge (ESD) Precautions

Almost all electrical components can be damaged by electrostatic discharge (ESD) during handling. Component damage can occur at electrostatic discharge voltages as low as 50 volts.

The following guidelines will help prevent ESD damage when servicing the instrument or any electronic device.

- Disassemble instruments only in a static-free work area.
- Use a conductive work area to reduce static charges.
- Use a conductive wrist strap to reduce static charge accumulation.
- Minimize handling.
- Keep replacement parts in original static-free packaging.
- Remove all plastics, foam, vinyl, paper, and other static-generating materials from the immediate work area.
- Use only anti-static solder suckers.

Mechanical Disassembly

For procedures in this manual, the following tools are required for disassembly:

- T15 Torx driver
- T20 Torx driver (most disassembly)
- #2 Pozi-drive screw driver

WARNING

Shock hazard. Only service-trained personnel who are aware of the hazards involved should remove the instrument covers. To avoid electrical shock and personal injury, make sure to disconnect the power cord from the instrument before removing the covers. Some circuits are active and have power applied even when the power switch is turned off.

General Disassembly

- 1 Remove power and all cables from the instrument.
- 2 Remove the carrying handle by rotating the handle upright and pulling out from the sides of the instrument.



5 Disassembly and Repair

- 3 Remove the instrument bumpers.** Pull from a corner and stretch the bumpers off the instrument.



- 4 Remove the rear bezel.** Loosen the two captive screws in the rear bezel and remove the rear bezel.



- 5 Remove the cover.** Remove the screw in the bottom of the cover and slide the cover off the instrument.



Front Panel Removal

- 1 Remove on/off switch push rod.** Gently move the power switch push rod toward the front of the instrument to disengage it from the switch. Be careful not to twist or bend the push rod.

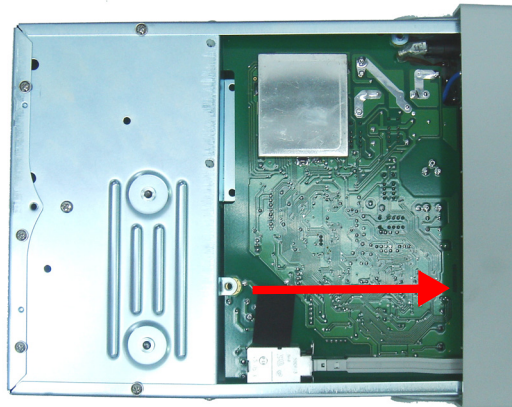

5 Disassembly and Repair

2 Remove the screw holding the front panel.



3 Disconnect the two ribbon cable connectors from the front panel.

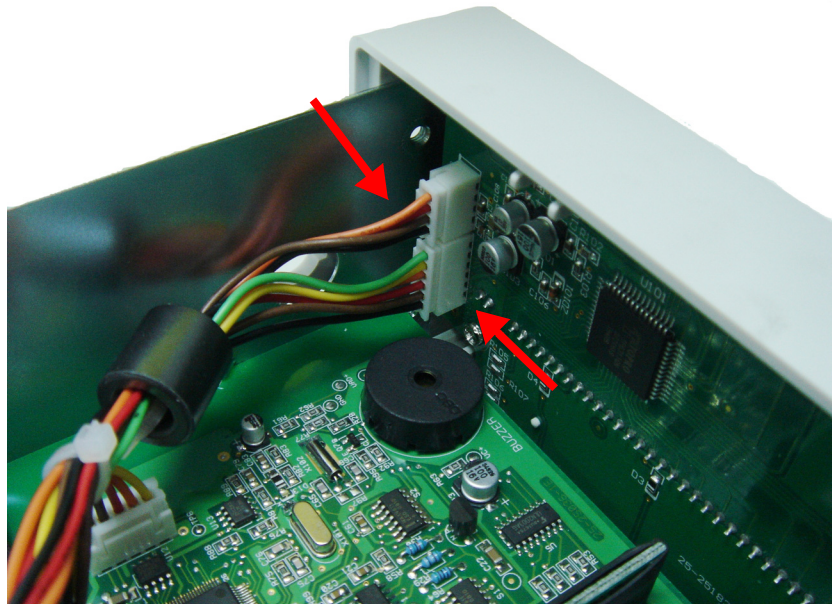

- 4 Disconnect the individual front panel wires shown below.

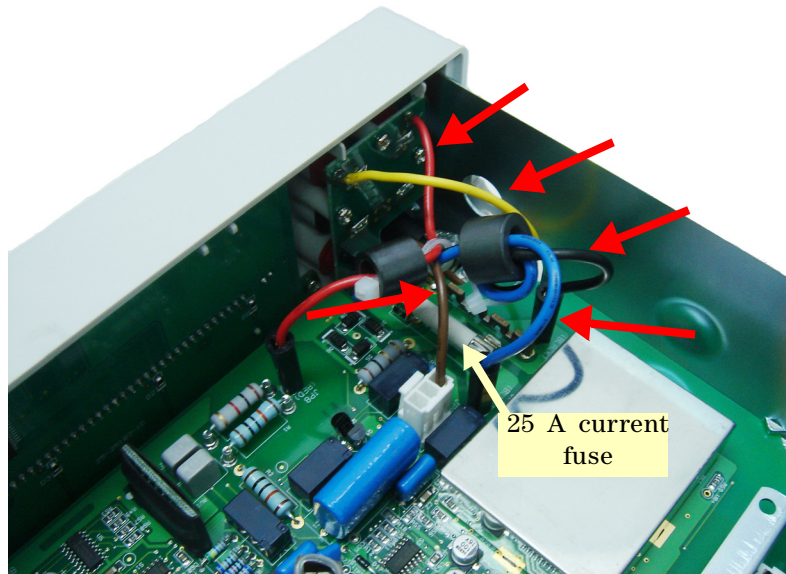

- 5 There is now enough play to allow the side of the front panel to be pried from the chassis and removed as an assembly.

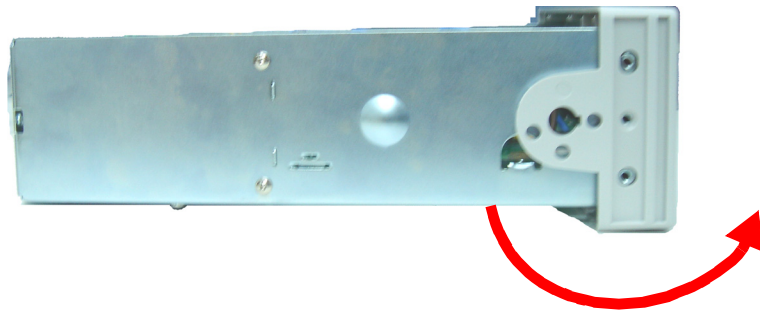

Front Panel Disassembly

- 1 Remove the keyboard and display assembly.** Remove the two screws holding the circuit board. Lift the keyboard and display assembly from the plastic housing.

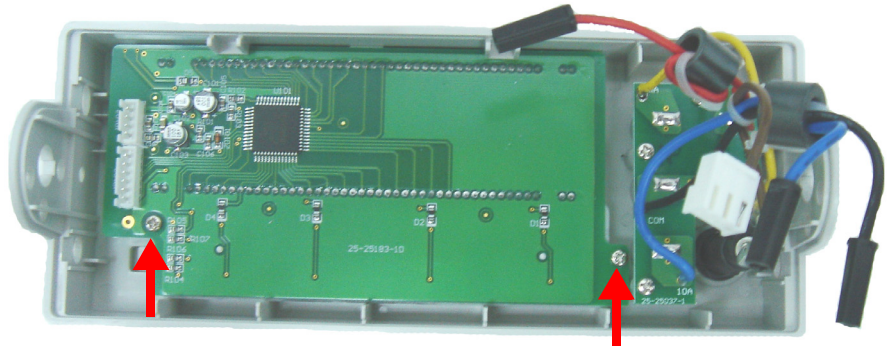

- a** The rubber keypad can now be pulled from the plastic housing.



Replaceable Parts

This section contains information for ordering replacement parts for your instrument. The parts lists are divided into the following sections.

Parts are listed in alphanumeric order according to their reference designators. The parts lists include a brief description of each part with applicable Agilent part number.

To Order Replaceable Parts

You can order replaceable parts from Agilent using the Agilent part number. Note that not all parts listed in this chapter are available as field-replaceable parts. To order replaceable parts from Agilent, do the following:

- 1 Contact your nearest Agilent Sales Office or Service Center.
- 2 Identify the parts by the Agilent part number shown in the replaceable parts list.
- 3 Provide the instrument model number and serial number.

Table 5-2 Replaceable Parts

| Part Number | Description |
|-----------------|--|
| A02-16-25077-8 | Keypad |
| U3401-60202 | Front panel assembly |
| A02-15-25453-1 | Pushrod |
| A02-1-25370-1C | Cover |
| A02-15-25200-1 | Rear bezel |
| U3401-40001 | Rubber bumper kit (front and rear) |
| U3606-45001 | Carrying handle |
| 2110-1432 | 0.63 A, 500 V fuse (mA input) |
| 2110-1431 | 25 A, 440 V Fast acting fuse (A input) |
| A02-62-25592-3U | 0.25 A, 250 V time-lag, low breaking, line power fuse |
| A02-62-25648-1U | 0.125 A, 250 V time-lag, low-breaking, line power fuse |
| A02-62-25604-1 | Front panel fuse holder |
| 34405-40001 | Fuse holder assembly on rear panel |

Rack Mounting

You can mount a single multimeter in a standard 19-inch rack cabinet using the optional rack mount kit.

NOTE

You must remove the carrying handle (see [page 75](#)) and the front and rear bumpers (see [page 76](#)) before rack mounting the multimeter.

To rack mount a single instrument, order adapter kit 5063-9240.

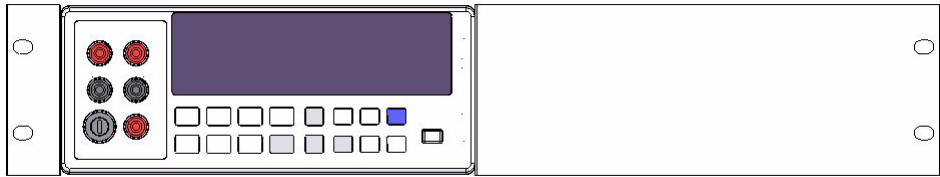

To rack mount two instruments side-by-side, order lock-in kit 5061-9694 and flange kit 5063-9212.

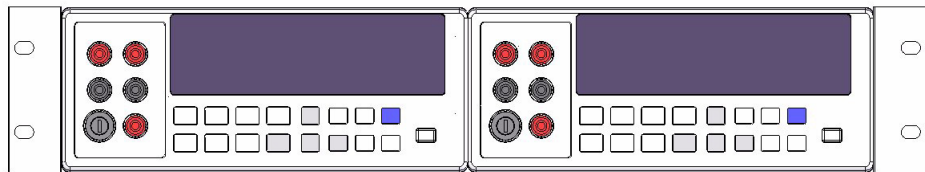

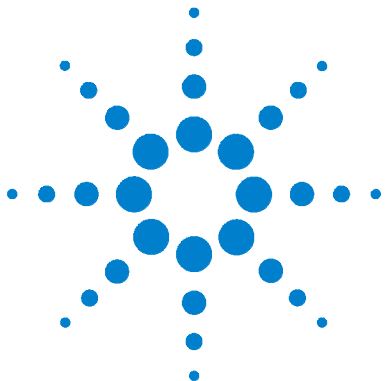

6 Specifications and Characteristics

| | |
|--|----|
| General Characteristics | 84 |
| Measurement Category | 86 |
| Measurement Category Definitions | 86 |
| Specifications | 87 |
| DC Voltage | 87 |
| DC Current | 87 |
| AC Voltage (true RMS, AC Coupling mode) | 88 |
| AC Voltage (true RMS, AC+DC Coupling mode) | 88 |
| AC Current (true RMS, AC Coupling mode) | 89 |
| AC Current (true RMS, AC+DC Coupling mode) | 90 |
| Resistance / Continuity | 90 |
| Diode Test/ Continuity | 91 |
| Frequency | 91 |
| Sensitivity for Voltage Measurement | 91 |
| Sensitivity for Current Measurement | 92 |
| Decibel Calculation | 92 |
| Supplemental Specifications | 93 |
| Display Counts and Reading Rates | 93 |
| Measurement Specifications | 93 |
| To Calculate Total Measurement Error | 98 |
| Accuracy Specifications | 99 |

This chapter specifies the characteristics and specifications of the U3401A.



General Characteristics

POWER SUPPLY

- 100V/120V/220V/240V \pm 10%
- AC line frequency 50 Hz to 60 Hz

POWER CONSUMPTION

16 VA maximum

INPUT POWER OPTION

Manual ranging (100 VAC to 240 VAC \pm 10%)

FUSE

Terminal :

- 25 A, 440 V FB fuse
- 0.63 A, 500 V FB fuse

Power line (according to country of destination):

- 0.25 A, 250 V SB fuse, or
- 0.125 A, 250 V SB fuse

DISPLAY

Highly visible vacuum fluorescent display (VFD)

OPERATING ENVIRONMENT

- Operating temperature from 0 °C to +50°C
- Relative humidity up to 80% at 28°C RH (non-condensing)
- Altitude up to 2000 meters
- Pollution degree 2
- For indoor use only

STORAGE COMPLIANCE

- -20°C to 60°C
- Relative humidity at 5% to 90% RH (non-condensing)

SAFETY COMPLIANCE

- IEC 61010-1:2001/EN61010-1:2001 (2nd Edition)
- Canada: CAN/CSA-C22.2 No. 61010-1-04
- USA:ANSI/UL 61010-1:2004

EMC COMPLIANCE

- IEC61326-1:2005 / EN61326-1:2006
- Canada: ICES/NMB-001:2004
- Australia/New Zealand: AS/NZS CISPR11:2004

SHOCK AND VIBRATION

Tested to IEC/EN 60068-2

I/O CONNECTOR

Output connectors

I/O INTERFACE

RS232 (For calibration use only)

DIMENSIONS (W x H x D)

- 226.0 x 105.0 x 305.0 mm (with bumpers)
- 215.0 x 87.0 x 282.0 mm (without bumpers)

WEIGHT

3.44 Kg (with bumpers)

WARRANTY

- One year for U3401A
- Three months for standard shipped accessories

CALIBRATION CYCLE

One Year

WARM UP TIME

At least 30 minutes

Measurement Category

The U3401A is intended to be used for measurement under Measurement Category II, 300 V for altitude up to 2000 m.

Measurement Category Definitions

| | |
|---------------------|--|
| Measurement CAT I | Measurements performed on circuits that are not directly connected to MAINS. For example, measurements on circuits that are not derived from MAINS, and specifically protected (internal) mains-derived circuits. |
| Measurement CAT II | Measurements performed on circuits that are directly connected to the low voltage installation. For example, measurements on household appliances, portable tools, and similar equipment. |
| Measurement CAT III | Measurements performed in fixed building installation. For example, measurements on distribution boards, circuit breakers, wiring (including cables), bus bars, junction boxes, switches, socket outlets in fixed installation, equipment for industrial use, and stationary motors with permanent connections to fixed installation. |
| Measurement CAT IV | Measurements performed at the source of the low voltage installation. For example, electricity meters, measurements on primary overcurrent protection devices, and ripple control units. |

Specifications

DC Voltage

Table 6-1 DCV resolution, full scale reading and accuracy [\pm (% of reading + count)]

| Range | Resolution | Maximum reading | Accuracy (One year; 23°C \pm 5°C) | Typical input impedance ^[2] |
|--------|-------------|-----------------------|-------------------------------------|--|
| 500 mV | 10 μ V | 510.00 | 0.02% + 4 | 10.0 M Ω |
| 5 V | 100 μ V | 5.1000 | 0.02% + 4 | 11.1 M Ω |
| 50 V | 1 mV | 51.000 | 0.02% + 4 | 10.1 M Ω |
| 500 V | 10 mV | 510.00 | 0.02% + 4 | 10.0 M Ω |
| 1000 V | 100 mV | 1200.0 ^[1] | 0.02% + 4 | 10.0 M Ω |

^[1] In 1000 V range, 1200 V is readable with audio warning.

^[2] Input impedance is in paralleled with capacitance <100 pF.

DC Current

Table 6-2 DCI resolution, full scale reading and accuracy [\pm (% of reading + count)]

| Range | Resolution | Maximum reading | Accuracy (One year; 23°C \pm 5°C) | Burden voltage ^[1] & shunt resistor |
|-------------|-------------|-----------------------|-------------------------------------|--|
| 500 μ A | 10 nA | 510.00 | 0.05% + 5 | <0.06 V / 100 Ω |
| 5 mA | 100 nA | 5.1000 | 0.05% + 4 | <0.6 V / 100 Ω |
| 50 mA | 1 μ A | 51.000 | 0.05% + 4 | <0.08 V / 1 Ω |
| 500 mA | 10 μ A | 510.00 | 0.05% + 4 | <0.8 V / 1 Ω |
| 5 A | 100 μ A | 5.1000 | 0.25% + 5 | <0.3 V / 0.01 Ω |
| 10 A | 1 mA | 20.000 ^[2] | 0.25% + 5 | <0.6 V / 0.01 Ω |

^[1] Typical at full scale reading and voltage across the input terminals.

^[2] In 10 A range, >10-20 Adc is readable for 20 seconds maximum with audio warning.

AC Voltage (true RMS, AC Coupling mode)

Table 6-3 ACV resolution and full scale reading [\pm (% of reading + count)]

| Range | Resolution | Maximum reading | Accuracy (One year; 23°C \pm 5°C) ^[2] | | | |
|--------|-------------|-----------------------|--|--------------------------|------------------------|------------------------|
| | | | 30 Hz to 50 Hz | 50 Hz to 10 kHz | 10 kHz to 30 kHz | 30 kHz to 100 kHz |
| 500 mV | 10 μ V | 510.00 | 1% + 40 | 0.5% + 40 | 2% + 60 | 3% + 120 |
| 5 V | 100 μ V | 5.1000 | 1% + 20 | 0.35% + 15 | 1% + 20 | 3% + 50 |
| 50 V | 1 mV | 51.000 | 1% + 20 | 0.35% + 15 | 1% + 20 | 3% + 50 |
| 500 V | 10 mV | 510.00 | Not specified | 0.5% + 15 | 1% + 20 ^[3] | 3% + 50 ^[3] |
| 750 V | 100 mV | 1000.0 ^[1] | Not specified | 0.5% + 15 ^[4] | 1% + 20 ^[3] | Not specified |

^[1] In 750 V range, 1000.0 V is readable with audio warning.

^[2] Accuracy specified at input >5% of range.

^[3] Input Voltage <200 V RMS.

^[4] For 5 kHz to 10 kHz, the accuracy is 0.7% + 15.

AC Voltage (true RMS, AC+DC Coupling mode)

Table 6-4 ACV_{ac+dc} resolution and full scale reading [\pm (% of reading + count)]

| Range | Resolution | Maximum reading | Accuracy (One year; 23°C \pm 5°C) ^[2] | | |
|--------|-------------|-----------------------|--|------------------------|------------------------|
| | | | 50 Hz to 10 kHz | 10 kHz to 30 kHz | 30 kHz to 100 kHz |
| 500 mV | 10 μ V | 510.00 | 0.5% + 50 | 2% + 70 | 3% + 130 |
| 5 V | 100 μ V | 5.1000 | 0.5% + 25 | 1% + 30 | 3% + 60 |
| 50 V | 1 mV | 51.000 | 0.5% + 25 | 1% + 30 | 3% + 60 |
| 500 V | 10 mV | 510.00 | 0.5% + 25 | 1% + 30 ^[3] | 3% + 60 ^[3] |
| 750 V | 100 mV | 1000.0 ^[1] | 0.5% + 25 ^[4] | 1% + 30 ^[3] | Not specified |

^[1] In 750 V range, 1000.0 V is readable with audio warning.

^[2] Accuracy specified at input >5% of range.

^[3] Input Voltage <200 V RMS.

^[4] For 5 kHz to 10 kHz, the accuracy is 0.7% + 25.

AC Current (true RMS, AC Coupling mode)

Table 6-5 ACI resolution, full scale reading, and burden voltage [\pm (% of reading + count)]

| Range | Resolution | Maximum reading | Accuracy (One year; 23°C \pm 5°C) ^[5] | | | | Burden voltage ^[1] and shunt resistor |
|-------------|-------------|-----------------------|--|----------------|----------------|------------------------|--|
| | | | 30 Hz to 50 Hz | 50 Hz to 2 kHz | 2 kHz to 5 kHz | 5 kHz to 20 kHz | |
| 500 μ A | 10 nA | 510.00 | 1.5% + 50 | 0.5% + 20 | 1.5% + 50 | 3% + 75 ^[4] | <0.06 V/100 Ω |
| 5 mA | 100 nA | 5.1000 | 1.5% + 40 | 0.5% + 20 | 1.5% + 40 | 3% + 60 | <0.6 V/100 Ω |
| 50 mA | 1 μ A | 51.000 | 1.5% + 40 | 0.5% + 20 | 1.5% + 40 | 3% + 60 | <0.08 V/1 Ω |
| 500 mA | 10 μ A | 510.00 | 1.5% + 40 | 0.5% + 20 | 1.5% + 40 | 3% + 60 | <0.8 V/1 Ω |
| 5 A | 100 μ A | 5.1000 | 2% + 40 ^[3] | 0.5% + 30 | Not Specified | | <0.3 V/0.01 Ω |
| 10 A | 1 mA | 20.000 ^[2] | 2% + 40 ^[3] | (<1kHz) | | | <0.6 V/0.01 Ω |

^[1] Typical at full range reading and voltage across the input terminals.

^[2] In 10 A range, >10-20 Aac is readable for 20 seconds maximum with audio warning.

^[3] Input Current < 3 A RMS.

^[4] Input Current >35 μ A RMS.

^[5] Accuracy specified at input >5% of range and >1 A for 10 A range except other specified.

AC Current (true RMS, AC+DC Coupling mode)

Table 6-6 ACI_{ac+dc} resolution, full scale reading, and burden voltage [\pm (% of reading + count)]

| Range | Resolution | Maximum reading | Accuracy (One year; 23°C \pm 5°C) ^[4] | | | Burden voltage ^[1] and shunt resistor |
|-------------|-------------|-----------------------|--|----------------|------------------------|--|
| | | | 50 Hz to 2 kHz | 2 kHz to 5 kHz | 5 kHz to 20 kHz | |
| 500 μ A | 10 nA | 510.00 | 0.5% + 30 | 1.5% + 60 | 3% + 85 ^[3] | <0.06 V/100 Ω |
| 5 mA | 100 nA | 5.1000 | 0.5% + 30 | 1.5% + 50 | 3% + 70 | <0.6 V/100 Ω |
| 50 mA | 1 μ A | 51.000 | 0.5% + 30 | 1.5% + 50 | 3% + 70 | <0.08 V/1 Ω |
| 500 mA | 10 μ A | 510.00 | 0.5% + 30 | 1.5% + 50 | 3% + 70 | <0.8 V/1 Ω |
| 5 A | 100 μ A | 5.1000 | 0.5% + 40 | Not Specified | | <0.3 V/0.01 Ω |
| 10 A | 1 mA | 20.000 ^[2] | (<1kHz) | Not Specified | | <0.6 V/0.01 Ω |

^[1] Typical at full scale reading and voltage across the input terminals.

^[2] In 10 A range, >10-20 Aac is readable for 20 seconds maximum with audio warning.

^[3] Input current > 35 μ A RMS.

^[4] Accuracy specified at input >5% of range and >1 A for 10 A range except other specified.

Resistance / Continuity

Table 6-7 Resistance resolution, full scale reading, and accuracy [\pm (% of reading + count)]

| Range ^[1] | Resolution | Maximum reading | Test current | Accuracy (One year; 23°C \pm 5°C) |
|----------------------|----------------|-----------------|--------------|-------------------------------------|
| 500 Ω | 10 m Ω | 510.00 | 0.5 mA | 0.1% + 5 ^[2] |
| 5 k Ω | 100 m Ω | 5.1000 | 0.45 mA | 0.1% + 3 ^[2] |
| 50 k Ω | 1 Ω | 51.000 | 45 μ A | 0.1% + 3 |
| 500 k Ω | 10 Ω | 510.00 | 4.5 μ A | 0.1% + 3 |
| 5 M Ω | 100 Ω | 5.1000 | 450 nA | 0.1% + 3 |
| 50 M Ω | 1 K Ω | 51.000 | 45 nA | 0.3% + 3 |

^[1] In order to eliminate the noise interference, which might be induced to the test leads, it is recommended to use a shielded test cable for measuring resistance above 500 K Ω .

^[2] Use relative operation. If relative operation is not used, add 0.2 Ω additional error.

Diode Test/ Continuity

Table 6-8 Diode / continuity resolution and full scale reading

| Range | Resolution | Maximum reading | Accuracy (One year; 23°C ± 5°C) |
|-------|------------|-----------------|---------------------------------|
| 2.3 V | 100 µV | 2.3000 V | 0.05% + 5 |

Frequency

Table 6-9 Frequency resolution and accuracy [\pm (% of reading + count)]

| Range | Measurement range | Resolution | Maximum reading | Accuracy (One year; 23°C ± 5°C) |
|---------|-------------------|------------|-----------------|---------------------------------|
| 500 Hz | 5 Hz to 500 Hz | 0.01 Hz | 510.00 | 0.01% + 5 |
| 5 kHz | 500 Hz to 5 kHz | 0.1 Hz | 5.1000 | 0.01% + 3 |
| 50 kHz | 5 kHz to 50 kHz | 1 Hz | 51.000 | 0.01% + 3 |
| 500 kHz | 50 kHz to 500 kHz | 10 Hz | 999.99 | 0.01% + 3 |

Sensitivity for Voltage Measurement

Table 6-10 Sensitivity for voltage measurement

| Range | Minimum sensitivity (RMS Sine-wave) | |
|--------|-------------------------------------|--------------------|
| | 5 Hz to 100 kHz | 100 kHz to 500 kHz |
| 500 mV | 35 mV | 200 mV |
| 5 V | 0.25 V | 0.5 V |
| 50 V | 2.5 V | 5 V |
| 500 V | 25 V | NO SPEC |
| 750 V | 50 V | NO SPEC |

Sensitivity for Current Measurement

Table 6-11 Sensitivity for current measurement

| Range | Minimum sensitivity (RMS Sine-wave) |
|-------------|-------------------------------------|
| | 30 Hz to 20 kHz |
| 500 μ A | 35 μ A |
| 5 mA | 0.25 mA |
| 50 mA | 2.5 mA |
| 500 mA | 25 mA |
| 5 A | 0.25 mA (<2 kHz) |
| 10 A | 2.5 A (<2 kHz) |

Decibel Calculation

Table 6-12 Range and accuracy (dB)

| Voltage range ^{[1][2]} | Input voltage | dBm ^[3] range at 600 Ω ref | Accuracy(One year; 23°C \pm 5°C) (dB) | | |
|---------------------------------|-----------------|---|---|--------------------|--------------------|
| | | | 30 Hz to 50 Hz | 50 Hz to 10 kHz | 10 kHz to 100 kHz |
| 500 mV | 20 mV to 500 mV | -29.82 to -3.80 | 0.3 | 0.3 | 0.7 |
| 5 V | 500 mV to 5 V | -3.80 to 16.20 | 0.2 | 0.2 | 0.5 |
| 50 V | 5 V to 50 V | 16.20 to 36.20 | 0.2 | 0.2 | 0.5 |
| 500 V | 50 V to 500 V | 36.20 to 56.20 | 0.2 ^[5] | 0.2 | 0.5 ^[5] |
| 1000 V (dc) | 500 V to 1000 V | 56.20 to 62.22 | Not Specified | 0.2 ^[4] | Not specified |
| 750 V (ac) | 500 V to 750 V | 56.20 to 59.72 | | | |

[1] Autoranging is used when dBm operation is enabled.

[2] In 1000 V (dc) range, 1200 V is readable. In 750 V (ac) range, 1000 V is readable.

[3] Reading displayed in dB when Rel operation is used.

[4] For input voltage at frequency between 50 Hz to 1 kHz.

[5] Input Voltage <200 V RMS.

Supplemental Specifications

Display Counts and Reading Rates

Table 6-13 Full scale display counts

| | |
|----------------------|-------|
| Display Count | 50000 |
|----------------------|-------|

Measurement Specifications

Table 6-14 Supplemental measurement specifications

| Measurement | | Specification |
|--------------------|-----------------------|--|
| DC Voltage | Measurement method | Sigma Delta A-to-D converter |
| | Input resistance | 10 M Ω \pm range (typical) |
| | Maximum input voltage | 1000 VDC or PEAK AC on all ranges |
| | Input protection | 1000 V on all ranges |
| | Response time | Approximate 1.0 second when the displayed reading reaches 99.9% DC value of the tested input signal at the same range. |
| DC current | Shunt resistance | 0.01 Ω to 100 Ω for 500 μ A to 10 A ranges |
| | Response time | Approximate 1.0 second when the displayed reading reaches 99.9% DC value of the tested input signal at the same range. |

Table 6-14 Supplemental measurement specifications

| Measurement | | Specification |
|---|-----------------------|--|
| AC voltage | Measurement method | AC coupled true RMS – measure the AC component with up to 400 VDC bias on any range |
| | Crest factor | Maximum 3:0 at full scale |
| | Input Impedance | 1 MΩ in parallel with <100 pF of all ranges |
| | Maximum input voltage | 1000 V RMS / 1400 V PEAK 2x10 ⁷ V-Hz product on any range, common mode input 1x10 ⁶ V-Hz product on any range, normal mode input |
| | Overload ranging | Will select higher range if peak input overload is detected during autoranging. Overload is reported in manual ranging. |
| | Input protection | 1000 V on all ranges |
| | Response time | Approximate 1.5 second when the displayed reading reaches 99.9% AC value of the tested input signal at the same range. |
| AC voltage (true RMS, AC+ DC coupling mode) | Measurement method | AC coupled true RMS — measure the AC component with up to 400 VDC bias on any range |
| | Crest factor | Maximum 3:0 at full scale |
| | Input impedance | 1 MΩ in parallel with <100 pF |
| | Maximum input voltage | 1000 V RMS / 1400 V PEAK 2x10 ⁷ V-Hz product on any range, common mode input 1x10 ⁶ V-Hz product on any range, normal mode input |
| | Overload ranging | Will select higher range if peak input overload is detected during autoranging. Overload is reported in manual ranging. |
| | Input protection | 1000 V RMS on all ranges |
| | Response time | Approximate 1.5 second when the displayed reading reaches 99.9% AC value of the tested input signal at the same range. |

Table 6-14 Supplemental measurement specifications

| Measurement | | Specification |
|--|----------------------|--|
| AC current (true RMS, AC coupling mode) | Measurement method | DC coupled to the fuse and current shunt, AC coupled true rms measurement (measures the AC component only) |
| | Crest factor | Maximum 3:0 at full scale |
| | Shunt resistance | 0.01 Ω to 100 Ω for 500 μ A to 10 A ranges |
| | Input protection | Front panel fuse 630 mA, 500 V, Internal 25 A, 440 V |
| | Reponse time | Approximate 1.5 second when the displayed reading reaches 99.9% AC value of the tested input signal at the same range. |
| AC current (true RMS, AC+DC coupling mode) | Measurement method | AC+DC coupled to the fuse and current shunt, AC+DC coupled true RMS measurement (measures the AC component only) |
| | Crest factor | Maximum 3:0 at full scale |
| | Measurement range | VDC and VAC are automatically set at the same range |
| | Response time | Approximate 1.5 second when the displayed reading reaches 99.9% AC value of the tested input signal at the same range. |
| Resistance | Measurement method | Two-wire Ohms |
| | Open-circuit voltage | Limited to +6.0 VDC |
| | Zeroing error | 0.05 Ω or less(excluding test lead resistances) in each range when Rel operation is used |
| | Input protection | 500 V DC or AC RMS |
| | Response time | Approximately 1.5 seconds for 5 M Ω and ranges below 5 M Ω . |

Table 6-14 Supplemental measurement specifications

| Measurement | | Specification |
|--------------------------------|---|--|
| Diode / Continuity | Measurement method | 0.83 mA±0.2% constant current source, open-circuit voltage limited to < 5 V |
| | Test current | Approximately 0.5 mADC |
| | Open-circuit voltage | Limited to < +6.0 VDC |
| | Continuity threshold | 10 Ω fixed |
| | Continuity level | Approximately below +50 m VDC |
| | Audible tone | Continuous beep for continuity and single tone for normal forward-biased diode or semiconductor junction. |
| | Input protection | 500 V DC or AC RMS |
| Frequency | Measurement method | Reciprocal counting technique. AC coupled input using AC voltage function |
| | Crest factor | Maximum 3:0 at full scale |
| | Signal level | 10% of range to full scale input on all ranges |
| | Gate time | 0.1 s or 1 period of the input signal, whichever is longer. |
| | Input impedance | 1 MΩ in parallel with <100 pF of all ranges |
| | Maximum input voltage | 1000 V RMS / 1400 V PEAK 2x10 ⁷ V-Hz product on any range, common mode input 1x10 ⁶ V-Hz product on any range, normal mode input |
| | Input protection | 1000 V RMS on all ranges |
| | Response time | Approximately 1 second when the displayed reading reaches 99.9% of frequency value. |
| Measurement Noise Rejection | Common mode reject ratio (CMRR) for 1 kΩ unbalanced LO lead | 50/60 Hz ± 0.1% : DC >90 dB |
| | Normal mode rejection ratio (NMRR) | 50/60 Hz ± 0.1% : >50 dB |
| | Response time | Approximately 1 second when the displayed reading reaches 99.9% of frequenc t value. |

Table 6-14 Supplemental measurement specifications

| | | |
|----------------|------------------------------------|---|
| dBm Operation | 0 dBm | 1 mW at 600 Ω reference impedance |
| | Resolution | 0.01 dB for all ranges |
| | Reference impedance ^[1] | 2 Ω ^[2] , 4 Ω ^[2] , 8 Ω ^[2] , 16 Ω ^[2] , 50 Ω , 75 Ω , 93 Ω , 110 Ω , 124 Ω , 125 Ω , 135 Ω , 150 Ω , 250 Ω , 300 Ω , 500 Ω , 600 Ω , 800 Ω , 900 Ω , 1000 Ω , 1200 Ω , 8000 Ω |
| Math operation | | dBm, Rel, MinMax, COMP, Hold, Percentage |
| I/O Interface | | RS232 ^[3] |

^[1] Reference impedance is displayed on the secondary display.

^[2] Reading displayed in watts (Audio power).

^[3] For calibration use only.

NOTE

When V_{ac+dc} measurement function is selected, the VDC input impedance is parallel with an AC-couples 1.1 M Ω divider.

To Calculate Total Measurement Error

The multimeter's accuracy specifications are expressed in the form:

(% of reading + count)

In addition to the reading error and count error, you may need to add additional errors for certain operating conditions. Check the list below to make sure you include all measurement errors for a given function. Also, make sure you apply the conditions as described in the footnotes on the specification pages.

- If you are operating the multimeter outside the temperature range specified, apply an additional temperature coefficient error.
- For AC voltage and AC current measurements, you may need to apply an additional low frequency error or crest factor error.

Accuracy Specifications

Transfer Accuracy

Transfer accuracy refers to the error introduced by the multimeter due to noise and short-term drift. This error becomes apparent when comparing two nearly-equal signals for the purpose of “transferring” the known accuracy of one device to the other.

One-Year Accuracy

These long-term accuracy specifications are valid at the calibration temperature (T_{cal}) $\pm 5^{\circ}\text{C}$ temperature range. These specifications include the initial calibration errors plus the multimeter’s long-term drift errors.

Temperature Coefficients

Accuracy is usually specified at the calibration temperature (T_{cal}) $\pm 5^{\circ}\text{C}$ temperature range. This is a common temperature range for many operating environments. You must add additional temperature coefficient errors to the accuracy specification if you are operating the multimeter at 0°C to 18°C and 28°C to 50°C temperature range (the specification is per $^{\circ}\text{C}$).

Temperature Coefficient = add $\pm 0.15 \times$ [the applicable accuracy/ $^{\circ}\text{C}$]

6 Specifications and Characteristics

www.agilent.com

Contact us

To obtain service, warranty or technical support assistance, contact us at the following phone numbers:

United States:

(tel) 800 829 4444 (fax) 800 829 4433

Canada:

(tel) 877 894 4414 (fax) 800 746 4866

China:

(tel) 800 810 0189 (fax) 800 820 2816

Europe:

(tel) 31 20 547 2111

Japan:

(tel) (81) 426 56 7832 (fax) (81) 426 56 7840

Korea:

(tel) (080) 769 0800 (fax) (080) 769 0900

Latin America:

(tel) (305) 269 7500

Taiwan:

(tel) 0800 047 866 (fax) 0800 286 331

Other Asia Pacific Countries:

(tel) (65) 6375 8100 (fax) (65) 6755 0042

Or visit Agilent worldwide Web at:

www.agilent.com/find/assist

Product specifications and descriptions in this document are subject to change without notice. Always refer to the Agilent Web site for the latest revision.

© Agilent Technologies, Inc. 2009

Printed in Malaysia
First Edition, May 29, 2009

U3401-90001



Agilent Technologies